



RESIDENTIAL AND LIGHT COMMERCIAL SOLUTIONS

LG Air Conditioning Technologies



ABOUT LG



About LG Electronics USA

LG Electronics USA, Inc., based in Englewood Cliffs, N.J., is the North American subsidiary of LG Electronics, Inc., a \$68 billion global innovator in technology and manufacturing. In the United States, LG sells a wide range of innovative home appliances, home entertainment products, commercial displays, air conditioning products, energy solutions and vehicle components. LG is a 2023 ENERGY STAR® Partner of the Year-Sustained Excellence. The company's commitment to environmental sustainability and its "Life's Good" marketing theme encompass how LG is dedicated to people's happiness by exceeding expectations today and tomorrow.

Please visit www.lg.com.

About LG Air Conditioning Technologies USA

LG Electronics USA's Air Conditioning Technologies business is based in Alpharetta, GA. LG is a leading player in the global air conditioning market, distributing both commercial and residential air conditioners and building management solutions. From consumer and individual units to industrial and specialized air conditioning solutions, LG provides a wide range of products for heating, ventilating and air conditioning. The company's industry-leading variable refrigerant flow (VRF) technology minimizes efficiency losses, provides sustainable energy savings, and offers some of the lowest lifecycle costs compared to other systems on the market today. Ten-time ENERGY STAR® Partner of the Year, LG Electronics USA (based in Englewood Cliffs, NJ), is the North American subsidiary of LG Electronics Inc., a \$68 billion global technology and manufacturing. For more information [Visit www.lghvac.com for more information](http://www.lghvac.com).

DUCT-FREE SOLUTIONS: A NEW WAY TO THINK ABOUT AIR CONDITIONING

LG air conditioning solutions are THE smart alternative to traditional air conditioning

For truly personalized comfort in all rooms, consider an LG Duct-Free Split air conditioning solution. LG air conditioning solutions make it easier to provide customized cooling and heating in every room without any bulky window units or costly ductwork, and with several indoor unit designs sure to match any décor, LG air conditioning solutions can be right for every job.

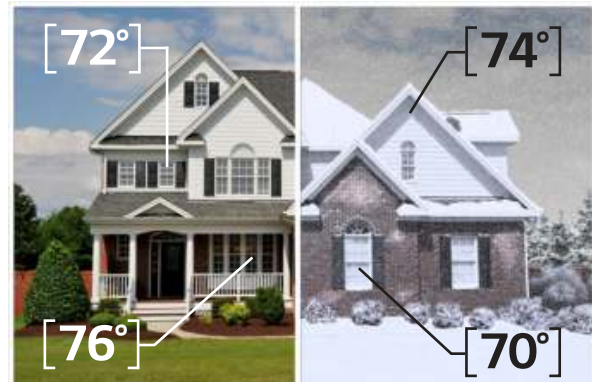

Our Commitment to You:

QUALITY LG air conditioning solutions reflect our commitment to building high-quality products. Operating state-of-the-art research & development facilities across the globe, LG invests heavily to ensure we are combining the best technologies with the best ideas.

TRAINING With several LG training academies throughout the United States and even more regional academies, LG makes it easy to learn about LG solutions and product applications.

PERFORMANCE LG makes a wide range of duct-free products with powerful cooling and heating capabilities while maintaining high energy efficiencies, quiet operation, and ease-of-use for personalization of comfort control for the end-user.

INNOVATION LG utilizes smart technology to enhance a homeowner's, and the technician's, experience in operating and providing routine maintenance or service on our air conditioning solutions. Our continued efforts to look for the most innovative ideas in HVAC, with our commitment to building green technologies, ensures that we will continue to develop and bring to market smarter, more sustainable products.



TABLE OF CONTENTS



INTRODUCTION

LG Advantages	5
Training & Recognition	7
Installation Best Practices	8
Key Features	9

SINGLE ZONE SOLUTIONS

Single Zone Line-up	11
Wall Mounted	
- ART COOL™ Mirror	12
- ART COOL™ Premier	13
- Extended Piping	14
- High Efficiency	15
- Standard Efficiency	16
- Mega	17
- Low Wall Console	18
Ceiling Mounted	
- Ceiling Cassette	19
Ducted	
- Convertible Mid Static Ducted	23
- High Static Ducted	25
- Multi-Position AHU	28

MULTI-ZONE SOLUTIONS

Multi-Zone Line-up	31
Outdoor Units	
- Multi F Outdoor Units	33
- Multi F MAX Outdoor Units	35
Indoor Units	
- Multi F Indoor Units	37
Multi F MAX Piping Accessories	43
Multi F Piping Summary	44

CONTROLS AND ACCESSORIES

Controls	45
Indoor Accessories	47
Air Technologies	47
Outdoor Accessories	48

REFERENCE TABLES

Controls & Accessories Compatibility	49
ENERGY STAR® Products	53
Model Number Nomenclature	56

LG ADVANTAGES



ROOM-BY-ROOM CONTROL

With a controller for each indoor unit, LG air conditioning solutions offer precise temperature settings in each zone while maximizing energy usage by heating or cooling only the zones in use.

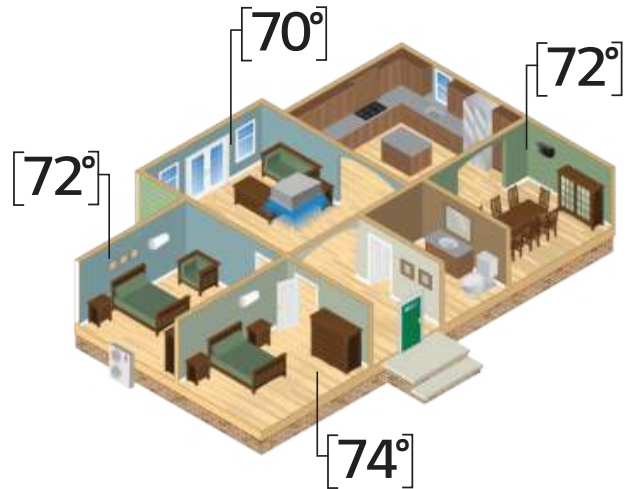

QUIET OPERATION

LG duct-free solutions operate at low sound levels, thanks to LG's unique low-vibration compressor, and Brushless Direct Current (BLDC) motor technology that eliminates unnecessary noise and allows for smooth operation.

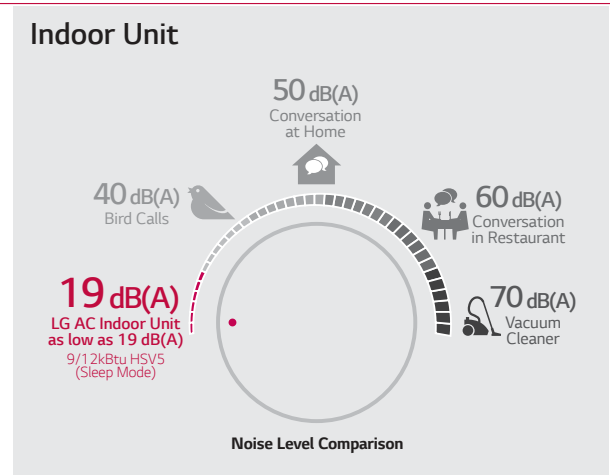

INVERTER TECHNOLOGY

Outdoor units with an inverter, variable-speed compressor use less energy and are measurably quieter than conventional air conditioning units. Unlike conventional systems that cycle on and off, an inverter compressor ramps up or down to match the capacity needed to maintain comfort levels selected by the homeowner within a conditioned zone.

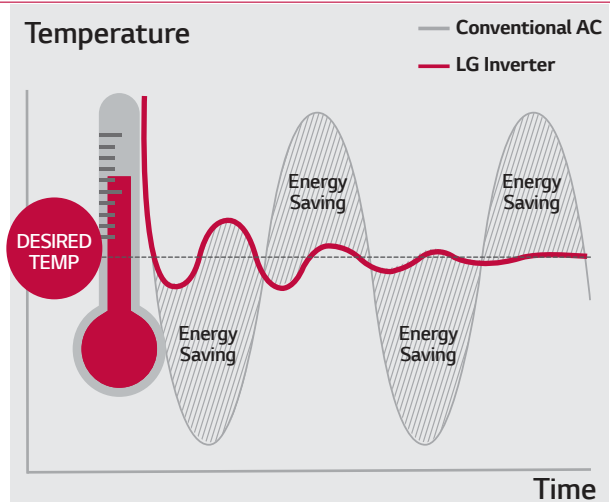

LG ADVANTAGES



LG THINQ®

Whenever, wherever and no matter how many air conditioners you have, LG ThinQ® let you easily access and control your air conditioner from your compatible smart device.¹



EASY INSTALLATION AND NO DUCTWORK

LG duct-free solutions are designed for easier and more efficient installation. They require little to no ductwork, and most indoor units can mount on any wall. Installation requires only a small hole to be drilled in the wall. Smaller indoor and outdoor units ensure space-saving convenience. Moreover, long refrigerant piping lengths increase the distance between the indoor and outdoor units, allowing for extra installation and design flexibility.

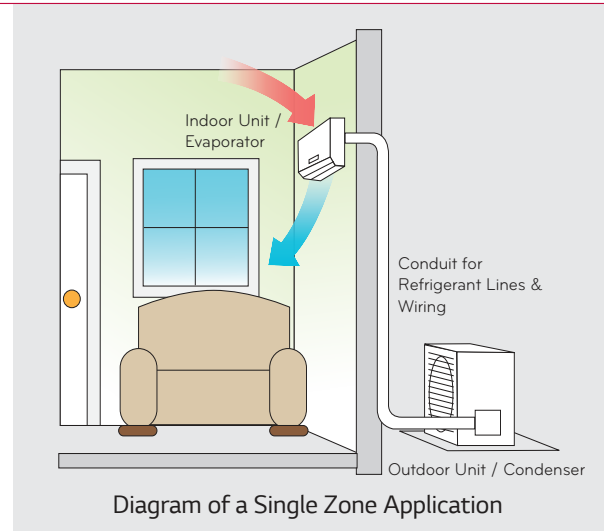

AIR QUALITY

Select LG duct-free indoor units utilize 3M™ Micro Protection Filters which reduce dust and microscopic particles including pollen, pet dander and odors. Additional primary filters are washable and antifungal, reducing life-time operation costs. Wall mount indoor units also self-clean the coil.

Self-Cleaning Indoor Coil

The interior of the air conditioner is maintained by drying off the heat exchanger, eliminating unwanted odors.



MiCRO Dust Filter Powered by 3M Tech.

3M Micro Protection Filter, a high air flow filter with low noise, collects harmful microscopic substances including pollen and fine dust.

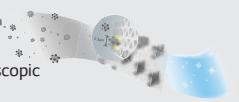

Air Filter

This primary filter captures dust size over 10µm.

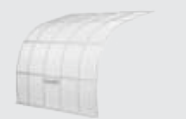

1. LG ThinQ® is only available for select models. See product details for full compatibility.
2. 3M™ is only available for select models. See product details for full compatibility.

TRAINING AND RECOGNITION



Training

LG US Air Conditioning Technologies is headquartered near Atlanta in Alpharetta, Georgia, along with a full training academy. Additional training academies are located in California, Texas, New Jersey, and Massachusetts. Since 2008, our academies have trained thousands on the advantages of LG air conditioning products, and even more have been trained through LG's online training modules. World-class trainers with years of experience teach classes in duct-free technology, with topics covering everything from installation to service for the full range of LG air conditioning products. LG also has a number of strategically placed partner academies throughout the United States that offer a number of LG-focused training classes as well.

For HVAC professionals, LG offers online instruction via our Learning Management System and classroom training at our training academies, strategically placed throughout the country. Training is open to all contractors; ask your LG Electronics authorized distributor for details. For more information and to find out how you can be part of the next training class near you visit training.lghvac.com

Service and Design Tools

As part of our commitment to innovation, LG has developed innovative ways to enhance the service technician's experience during routine maintenance or service with these tools:

- **Mobile LGMV** connects to select outdoor units and allows technicians to troubleshoot accurately by interfacing directly with the unit and following step-by-step troubleshooting guidelines. The Mobile LGMV module connects to a free smartphone app developed by LG factory engineers.
- **LATS HVAC** is a design tool for LG Air Conditioning Technologies solutions. Using drag and drop functionality, design your LG solution quickly and let LATS calculate critical details like output capacity and additional refrigerant and confirm pipe lengths are within allowable tolerances. Reach out to your local LG representative for help designing your next project with LATS to save time.



TAKE YOUR BUSINESS TO NEW LEVELS

The LG Pro Dealer Program provides specialized support and recognition for contractors who have been trained by factory teams to install LG Residential and Light Commercial Solutions, helping to set you apart from your competitors. Along with great incentives and recognition, the LG Pro Dealer Program provides the opportunity to qualify for an additional limited warranty, a website listing with LG Pro Dealer designation on the LG website's contractor locator, consumer lead referrals and local advertising materials. To find out how to put these tools to work for you, visit lghvac.com/prodealer

INSTALLATION BEST PRACTICES

For jobs small to large, look for opportunities to use LG comfort solutions everywhere! Explore the many applications of LG Single and Multi-Zone solutions: whole home renovations, older product replacements, home additions, energy savings opportunities, hot or cold zones ... and many, many more!

Sizing and installation accuracy are key factors for the optimal performance of an LG comfort solution. Increased energy efficiency, customizable design aesthetics and room by room comfort control are just a few of the benefits that come from a properly installed solution. Products should be installed in accordance with LG installation manuals and in compliance with applicable state and local codes.

Below are a few of the best practices used by Pro Dealers across the U.S. during installation.

Please refer to the appropriate Installation and Engineering manuals for installation instructions of LG air conditioning products.

Unit Placement (Indoor & Outdoor)

- Leave appropriate clearances on all sides of the indoor and outdoor units to allow for proper airflow as well as service access
- Include space for drainage to ensure condensate flows properly out of the unit
- Units should be properly anchored to prevent unnecessary vibrations

Additionally for indoor units:

- Keep unit away from any indoor steam or excessive heat
- No obstacles should be placed around unit
- ⊗ Do not install near a doorway or over a window
- Condensation drain should be routed away from the indoor unit to the outside

Wiring

- Use wire that fulfills or exceeds the minimum wire requirements:
 - ODU to IDU wiring: 14-4
- L1 and L2 are polarity sensitive on all models
- Indoor units are 208/230 volts (or 115 volt on two Mega models)
- Terminal 3 is 115 volt
- ⊗ Never use wire nuts or splices in wiring
- Use non-insulated spade connectors on all terminal connections
- Use a JIS screwdriver on terminal block to avoid stripping out the screws
- Only a dedicated electrical circuit is allowed
- Always ground indoor and outdoor unit
- Only connect one (1) end of the shielded cable if using shielded wire

***NOTE: All wiring must comply with applicable local and national codes.**

Piping

- Use only the correct line sizes as determined by the indoor unit
- Use only copper refrigerant piping
- Insulate both refrigerant lines independently of each other
- Flare connections using a 45-degree flaring tool
- ⊗ Do not exceed the maximum pipe length or install less than the required minimum
- ⊗ Do not make vertical loops in the refrigerant piping
- Support pipe runs from sagging or bending

Charging

- Leak test with dry nitrogen to at least 550 psi
- ⊗ Never use anything but soap bubbles designed for HVAC leak testing
- Use only an approved evacuation hose for proper evacuation and leak testing
- If possible, remove cores from system prior to starting evacuation
- Start with fresh vacuum pump oil and evacuate to less than 500 microns
- If refrigerant is added, use an electronic scale and weigh in the precise amount
- Open service valves prior to energizing the unit

Piping Torque Specification:

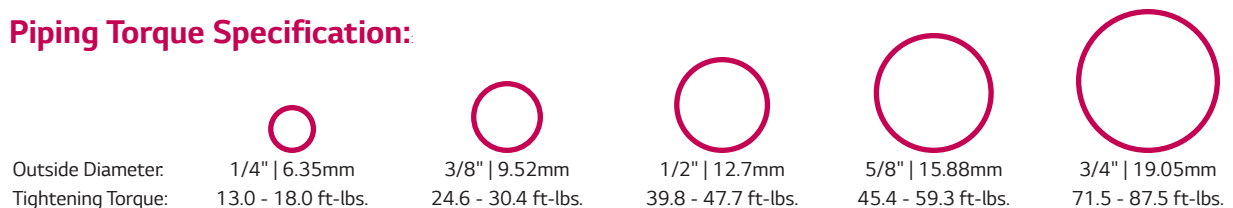

Installation and Service Tools:

- Quality Flaring Tool
- Digital Refrigerant Charging Scale
- Torque Wrench
- JIS Screwdriver
- Micron Gauge
- Vacuum Pump
- High-Quality Multimeter



KEY FEATURES



LGRED° HEAT TECHNOLOGY

Advanced technology that can exceed 100% of the rated heating capacity performance down to 5° F and continuous heating performance down to -13° F.

LGRED°
Powerful Heat Technology
RELIABLE TO EXTREME DEGREES



DEHUMIDIFYING MODE

Uses sensors in the indoor unit to accurately measure room temperature and control humidity by adjusting the setpoint and fan speed.



OPTIMIZED AIRFLOW



Jet Cool / Jet Heat Mode operates the unit at a high speed to quickly cool or heat a room.



Auto Operation adjusts the temperature and fan speed automatically to match the user's preference from three levels of comfort.

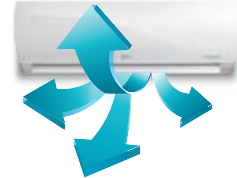

Swirl Wind / Chaos Wind allows for customized louver and fan speed operation to create a stronger, wider airflow for reduced temperature stratification and to provide more natural air circulation.



Art Cool™ Gallery 3D Airflow uniquely provides three-directional airflow for more natural and effective air circulation.



GOLD FIN

Gold Fin™ Coating is an anticorrosion coating to help protect your product from corrosive elements, allowing the coil to maintain excellent heat transfer properties for an extended time.



DEFROST CONTROL

Removes frost from the outdoor coil when ambient outdoor temperatures are low and simultaneously shuts down the indoor fan to prevent cold air from being blown into the controlled space.



AUTO SLEEP MODE

Automatically increases the temperature setting 2° F twice in 30 minute increments. The indoor unit shuts off when the timer setting is reached.



AUTO RESTART

Automatically restarts the system after a power failure.

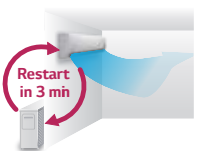

STYLISH DESIGN

LG air conditioning solutions come in a variety of indoor units, including the Art Cool™ Gallery, which includes a panel that works like a customizable picture frame. For Multi F solutions, choose from different capacities to match load demands appropriately while maintaining the aesthetic of any room's décor.



































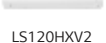











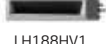





SINGLE-ZONE SOLUTIONS



SINGLE-ZONE SOLUTIONS

Lineup

		Btu/h	9,000	12,000	15,000	18,000	24,000	30,000	36,000	42,000	48,000	60,000
Wall Mounted	ART COOL™ Mirror											
		LA090HSV5	LA120HSV5			LA181HSV5						
	ART COOL™ Premier											
		LA090HYV3	LA120HYV3	LA150HYV3	LA180HYV3	LA240HYV3						
	Extended Piping											
							LS243HLV3	LS303HLV3	LS363HLV3			
	High Efficiency											
		LS090HSV5	LS120HSV5			LS181HSV5						
Standard Efficiency												
	LS090HFV3	LS120HFV3			LS180HFV3	LS240HFV3						
Mega 208/230V												
	LS090HEV2	LS120HEV2			LS180HEV2	LS240HEV2						
Mega 115V												
	LS090HXV2	LS120HXV2										
Low Wall Console												
	LQ090HV	LQ120HV										
Ceiling Mounted	Ceiling Cassette											
		LC098HV	LC128HV			LC188HV LC188HHV4	LC249HV LC249HHV		LC369HV LC369HHV	LC429HV LC429HHV	LC489HHV	
	Convertible Mid Static											
	LH098HV1	LH128HV1			LH188HV1 LH188HHV1	LH248HV1 LH248HHV1						
Ducted	High Static											
						LH248HHV4		LH368HV LH368HHV4	LH428HHV	LH488HHV		
	Multi-Position Air Handler Unit											
		LV120HCV			LV180HCV LV181HV LV181HHV4	LV240HCV LV241HV LV241HHV4	LV300HCV LV300HV	LV361HV LV361HHV4	LV420HV1 LV420HHV LV420HV2	LV480HV1 LV480HHV LV480HV2	LV600HV	

ART COOL™ MIRROR



LG ThinQ®

LA090HSV5
LA120HSV5
LA181HSV5



SINGLE-ZONE

WALL MOUNTED

Specification	Unit	LA090HSV5	LA120HSV5	LA181HSV5	
Indoor Unit		LAN090HSV5	LAN120HSV5	LAN181HSV5	
Outdoor Unit		LSU090HSV5	LSU120HSV5	LSU181HSV5	
Capacity ^{1,2}	Rated Cooling Capacity	Btu/h	9,000	12,000	18,000
	Cooling Capacity Range	Btu/h	1,023 - 12,625	1,023 - 13,785	3,070 - 29,515
	Rated Heating Capacity	Btu/h	10,900	13,600	21,600
	Heating Capacity Range	Btu/h	1,023 - 17,061	1,023 - 22,178	3,070 - 38,898
	Max Heating Capacity at 17°F	Btu/h	11,080	13,810	22,340
	Max Heating Capacity at 5°F	Btu/h	9,570	11,930	19,300
	Max Heating Capacity at -4°F	Btu/h	8,310	10,360	16,760
	SEER2, EER2		23.20, 14.50	22.00, 12.50	22.00, 12.50
	HSPF2		10.20	10.00	9.50
Power	Voltage (IDU)	V, Hz, Ø	208/230, 60, 1	208/230, 60, 1	208/230, 60, 1
	Voltage (ODU)	V, Hz, Ø	208/230, 60, 1	208/230, 60, 1	208/230, 60, 1
	Cooling Power Input	kW	0.62	0.96	1.43
	Heating Power Input	kW	0.71	1.04	1.73
	MCA, MOCP	A	10.0, 15.0	10.0, 15.0	19.0, 30.0
	Power/Communication Wiring ³	No. x AWG	4 x 14	4 x 14	4 x 14
	Rated Amps (Cool/Heat)	A	7.80 / 7.80	7.80 / 7.80	13.78 / 15.48
	ODU Heating Operation Range	°F WB	-4 - 65	-4 - 65	-4 - 65
Operation Range	ODU Cooling Operation Range	°F DB	14 - 118	14 - 118	14 - 118
	Optional Wind Baffle ⁴		ZLABGP01A (0°F)	ZLABGP01A (0°F)	ZLABGP04A (0°F)
	IDU Operation Range Cooling	°F WB	53 - 75	53 - 75	53 - 75
	IDU Operation Range Heating	°F DB	60 - 86	60 - 86	60 - 86
	Setpoint Range Cooling	°F	64 - 86	64 - 86	64 - 86
	Setpoint Range Heating	°F	60 - 86	60 - 86	60 - 86
Dimensions	IDU Dimensions (WxHxD)	in	32-15/16 x 12-1/8 x 7-9/16	32-15/16 x 12-1/8 x 7-9/16	39-9/32 x 13-19/32 x 8-11/32
	ODU Dimensions (WxHxD)	in	30-5/16 x 21-1/2 x 11-5/16	30-5/16 x 21-1/2 x 11-5/16	37-13/32 x 32-3/4 x 13
Weight	IDU Weight (Net/Shipping)	lbs	20.5 / 25.6	20.5 / 25.6	29.8 / 36.4
	ODU Weight (Net/Shipping)	lbs	74.1 / 78.9	74.1 / 78.9	127.9 / 145.5
Unit Data	Airflow (H/M/L) ⁵	CFM	459 / 338 / 317 / 194	459 / 338 / 317 / 194	706 / 530 / 477 / 371
	Dehumidification	pts/hr	2.70	2.70	5.50
	Compressor Type		Twin Rotary	Twin Rotary	Twin Rotary
	Refrigerant Type		R410A	R410A	R410A
Sound Pressure ⁶	Indoor (H/M/L/SL)	dB(A)	41 / 35 / 25 / 21	41 / 35 / 25 / 21	47 / 42 / 37 / 31
	Outdoor Max	dB(A)	51	51	55
	Liquid Pipe	in	1/4	1/4	3/8
	Vapor Pipe	in	3/8	3/8	5/8
Piping ⁷	Pipe Length (Min/Max)	ft	9.8 / 82.0	9.8 / 82.0	9.8 / 114.8
	Max Pipe Elevation	ft	49.2	49.2	49.2
	Precharge Pipe Length	ft	41.0	41.0	24.6
	Additional Refrigerant	oz/ft	0.22	0.22	0.38
	Drain (OD, ID)	in	27/32, 5/8	27/32, 5/8	27/32, 5/8
Controller	Supplied	AKB74955602	AKB74955602	AKB74955602	

Note:

¹Rated capacity at 0 ft. above sea level with 25 ft. of refrigerant line and a 0 ft. level difference between outdoor and indoor unit.

²Rated cooling capacity obtained with air entering the indoor unit at 80°F dry bulb (DB) and 67°F wet bulb (WB) and outdoor ambient conditions of 95°F dry bulb (DB) and 75°F wet bulb (WB).
Rated heating capacity obtained with air entering the indoor unit at 70°F dry bulb (DB) and 60°F wet bulb (WB) and outdoor ambient conditions of 47°F dry bulb (DB) and 43°F wet bulb (WB).
For capacity information, see engineering manual capacity tables.

³All power/communication wiring minimum 4-conductor, stranded, shielded, and must comply with applicable local and national codes.

⁴Installation of an optional Low Ambient Wind Baffle Kit will allow operation down to 0°F in cooling mode for applicable outdoor units.

⁵Airflow shown is in heating and cooling mode.

⁶Sound pressure levels are tested in an anechoic chamber under ISO Standard 3745 and are the same in both cooling and heating mode. These values can increase due to ambient conditions during operation.

⁷Piping lengths are equivalent.

Due to our commitment to continued innovation, some specifications may be changed without notification.

ART COOL™ PREMIER



LA090HYV3
LA120HYV3

LA150HYV3
LA180HYV3
LA240HYV3

LGRED[®]
LG ThinQ[®]



Specification	Unit	LA090HYV3	LA120HYV3	LA150HYV3	LA180HYV3	LA240HYV3
Indoor Unit		LAN090HYV3	LAN120HYV3	LAN150HYV3	LAN180HYV3	LAN240HYV3
Outdoor Unit		LAU090HYV3	LAU120HYV3	LAU150HYV3	LAU180HYV3	LAU240HYV3
Rated Cooling Capacity	Btu/h	9,000	12,000	15,000	18,000	22,000
Cooling Capacity Range	Btu/h	1,023 - 13,000	1,023 - 13,785	3,070 - 21,000	3,070 - 29,515	3,070 - 30,000
Rated Heating Capacity	Btu/h	11,000	13,600	18,000	21,600	26,000
Heating Capacity Range	Btu/h	1,023 - 20,472	1,023 - 22,178	3,070 - 25,200	3,070 - 32,000	3,070 - 36,200
Capacity ^{1,2}						
Max Heating Capacity at 17°F	Btu/h	11,940	14,760	21,430	24,920	27,360
Max Heating Capacity at 5°F	Btu/h	11,000	13,600	18,950	21,600	23,700
Max Heating Capacity at -13°F	Btu/h	8,030	9,640	14,660	15,680	17,740
SEER2, EER2		27.00, 15.80	25.50, 13.80	25.00, 15.00	24.00, 14.40	23.00, 13.00
HSPF2		13.50	11.20	11.00	10.80	10.00
Power						
Voltage (IDU)	V, Hz, Ø	208/230, 60, 1	208/230, 60, 1	208/230, 60, 1	208/230, 60, 1	208/230, 60, 1
Voltage (ODU)	V, Hz, Ø	208/230, 60, 1	208/230, 60, 1	208/230, 60, 1	208/230, 60, 1	208/230, 60, 1
Cooling Power Input	kW	0.57	0.87	1.00	1.25	1.69
Heating Power Input	kW	0.71	0.97	1.13	1.54	2.08
MCA, MOCP	A	11.2, 15.0	11.2, 15.0	19.0, 30.0	19.0, 30.0	19.0, 30.0
Power/Communication Wiring ³	No. x AWG	4 x 14	4 x 14	4 x 14	4 x 14	4 x 14
Rated Amps Cool/Heat	A	9.10 / 9.10	9.10 / 9.10	15.31 / 15.31	15.31 / 5.31	15.31 / 15.31
Operating Range						
ODU Heating Operation Range	°F WB	-13 - 65	-13 - 65	-13 - 65	-13 - 65	-13 - 65
ODU Cooling Operation Range	°F DB	14 - 118	14 - 118	14 - 118	14 - 118	14 - 118
Optional Wind Baffle ⁴		ZLABGP03A (0°F)	ZLABGP03A (0°F)	ZLABGP04A (0°F)	ZLABGP04A (0°F)	ZLABGP04A (0°F)
IDU Operation Range Cooling	°F WB	53 - 75	53 - 75	53 - 75	53 - 75	53 - 75
IDU Operation Range Heating	°F DB	60 - 86	60 - 86	60 - 86	60 - 86	60 - 86
Setpoint Range Cooling	°F	64 - 86	64 - 86	64 - 86	64 - 86	64 - 86
Setpoint Range Heating	°F	60 - 86	60 - 86	60 - 86	60 - 86	60 - 86
Dimensions						
IDU Dimensions (WxHxD)	in	39-9/32 x 13-19/32 x 8-9/32	39-9/32 x 13-19/32 x 8-9/32	41-23/32 x 14-3/16 x 10-7/16	41-23/32 x 14-3/16 x 10-7/16	41-23/32 x 14-3/16 x 10-7/16
ODU Dimensions (WxHxD)	in	34-1/4 x 25-19/32 x 13	34-1/4 x 25-19/32 x 13	37-13/32 x 32-3/4 x 13	37-13/32 x 32-3/4 x 13	37-13/32 x 32-3/4 x 13
Weight						
IDU Weight (Net/Shipping)	lbs	25.1 / 29.5	25.1 / 29.5	37.7 / 45.6	37.7 / 45.6	37.7 / 45.6
ODU Weight (Net/Shipping)	lbs	93.9 / 103.2	93.9 / 103.2	135.4 / 147.7	135.4 / 147.7	135.4 / 147.7
Unit Data						
Airflow (H/M/L) ⁵	CFM	530 / 424 / 353 / 184	530 / 424 / 353 / 184	813 / 601 / 495 / 389	813 / 601 / 495 / 389	813 / 601 / 495 / 389
Dehumidification	pts/hr	3.17	3.59	3.80	4.65	4.65
Compressor Type		Twin Rotary	Twin Rotary	Twin Rotary	Twin Rotary	Twin Rotary
Refrigerant Type		R410A	R410A	R410A	R410A	R410A
Sound Pressure ⁶						
Indoor (H/M/L/SL)	dB(A)	42/36/26/22	42/36/26/22	49/44/40/30	49/44/40/30	49/44/40/30
Outdoor Max	dB(A)	50	50	56	56	56
Piping ⁷						
Liquid Pipe	in	1/4	1/4	3/8	3/8	3/8
Vapor Pipe	in	3/8	3/8	5/8	5/8	5/8
Pipe Length (Min/Max)	ft	9.8 / 65.6	9.8 / 65.6	9.8 / 164.0	9.8 / 164.0	9.8 / 164.0
Max Pipe Elevation	ft	39.4	39.4	98.4	98.4	98.4
Precharge Pipe Length	ft	24.6	24.6	24.6	24.6	24.6
Additional Refrigerant	oz/ft	0.22	0.22	0.38	0.38	0.38
Drain (OD, ID)	in	25/32, 19/32	25/32, 19/32	25/32, 19/32	25/32, 19/32	25/32, 19/32
Controller	Supplied	AKB74955602	AKB74955602	AKB74955602	AKB74955602	AKB74955602

Note:

¹ Rated capacity at 0 ft. above sea level with 25 ft. of refrigerant line and a 0 ft. level difference between outdoor and indoor unit.

² Rated cooling capacity obtained with air entering the indoor unit at 80°F dry bulb (DB) and 67°F wet bulb (WB) and outdoor ambient conditions of 95°F dry bulb (DB) and 75°F wet bulb (WB).

³ Rated heating capacity obtained with air entering the indoor unit at 70°F dry bulb (DB) and 60°F wet bulb (WB) and outdoor ambient conditions of 47°F dry bulb (DB) and 43°F wet bulb (WB). For capacity information, see engineering manual capacity tables.

⁴ All power/communication wiring minimum 4-conductor, stranded, shielded, and must comply with applicable local and national codes.

⁵ Installation of an optional Low Ambient Wind Baffle Kit will allow operation down to 0°F in cooling mode for applicable outdoor units.

⁶ Airflow shown is in heating and cooling mode.

⁷ Sound pressure levels are tested in an anechoic chamber under ISO Standard 3745 and are the same in both cooling and heating mode. These values can increase due to ambient conditions during operation.

⁸ Piping lengths are equivalent.

⁹ LGRED applies to 9-18MBH models.

Due to our commitment to continued innovation, some specifications may be changed without notification.

EXTENDED PIPING



LG ThinQ®

LS243HLV3
LS303HLV3
LS363HLV3



SINGLE-ZONE

WALL MOUNTED

Specification	Unit	LS243HLV3	LS303HLV3	LS363HLV3
Indoor Unit		LSN243HLV3	LSN303HLV3	LSN363HLV3
Outdoor Unit		LSU243HLV3	LSU303HLV3	LSU363HLV3
Rated Cooling Capacity	Btu/h	22,000	30,000	33,000
Cooling Capacity Range	Btu/h	3,070 - 30,000	3,070 - 34,000	3,070 - 34,000
Rated Heating Capacity	Btu/h	26,000	32,400	35,200
Heating Capacity Range	Btu/h	3,070 - 36,200	3,070 - 38,900	3,070 - 38,900
Capacity ^{1,2}				
Max Heating Capacity at 17°F	Btu/h	27,360	32,500	35,740
Max Heating Capacity at 5°F	Btu/h	23,700	28,080	30,890
Max Heating Capacity at -4°F	Btu/h	21,170	24,390	26,820
SEER2, EER2		22.00, 13.00	20.50, 11.30	19.00, 10.00
HSPF2		9.50	7.90	7.90
Power				
Voltage (IDU)	V, Hz, Ø	208/230, 60, 1	208/230, 60, 1	208/230, 60, 1
Voltage (ODU)	V, Hz, Ø	208/230, 60, 1	208/230, 60, 1	208/230, 60, 1
Cooling Power Input	kW	1.69	2.66	3.30
Heating Power Input	kW	2.08	2.75	3.12
MCA, MOCP	A	19.0, 30.0	23.0, 30.0	23.0, 30.0
Power/Communication Wiring ³	No. x AWG	4 x 14	4 x 14	4 x 14
Rated Amps Cool/Heat	A	15.31 / 15.31	15.85 / 15.85	15.85 / 15.85
Operating Range				
ODU Heating Operation Range	°F WB	-4 - 65	-4 - 65	-4 - 65
ODU Cooling Operation Range	°F DB	14 - 118	14 - 118	14 - 118
Optional Wind Baffle ⁴		ZLABGP04A (0°F)	ZLABGP04A (0°F)	ZLABGP04A (0°F)
IDU Operation Range Cooling	°F WB	53 - 75	53 - 75	53 - 75
IDU Operation Range Heating	°F DB	60 - 86	60 - 86	60 - 86
Setpoint Range Cooling	°F	64 - 86	64 - 86	64 - 86
Setpoint Range Heating	°F	60 - 86	60 - 86	60 - 86
Dimensions				
IDU Dimensions (WxHxD)	in	41-23/32 x 14-3/16 x 10-7/16	47-1/4 x 14-3/16 x 10-7/16	47-1/4 x 14-3/16 x 10-7/16
ODU Dimensions (WxHxD)	in	37-13/32 x 32-3/4 x 13	37-13/32 x 32-3/4 x 13	37-13/32 x 32-3/4 x 13
Weight				
IDU Weight (Net/Shipping)	lbs	36.6 / 44.5	40.8 / 48.9	40.8 / 48.9
ODU Weight (Net/Shipping)	lbs	135.4 / 147.7	147.9 / 160.3	147.9 / 160.3
Unit Data				
Airflow (Max/H/M/L) ⁵	CFM	813 / 601 / 495 / 389	1,095 / 883 / 742 / 601	1,095 / 883 / 742 / 601
Dehumidification	pts/hr	4.65	5.49	5.49
Compressor Type		Twin Rotary	Twin Rotary	Twin Rotary
Refrigerant Type		R410A	R410A	R410A
Sound Pressure ⁶				
Indoor (H/M/L/SL)	dB(A)	49/44/40/30	51/47/43/33	51/47/43/33
Outdoor Max	dB(A)	56	58	58
Piping ⁷				
Liquid Pipe	in	3/8 Flare	3/8 Flare	3/8 Flare
Vapor Pipe	in	5/8 Flare	5/8 Flare	5/8 Flare
Pipe Length (Min/Max)	ft	9.8 / 164.0	9.8 / 164.0	9.8 / 164.0
Max Pipe Elevation	ft	98.4	98.4	98.4
Precharge Pipe Length	ft	24.6	24.6	24.6
Additional Refrigerant	oz/ft	0.38	0.38	0.38
Drain (OD, ID)	in	25/32, 19/32	25/32, 19/32	25/32, 19/32
Controller	Supplied	AKB74955602	AKB74955602	AKB74955602

Note:

¹ Rated capacity at 0 ft. above sea level with 25 ft. of refrigerant line and a 0 ft. level difference between outdoor and indoor unit.

² Rated cooling capacity obtained with air entering the indoor unit at 80°F dry bulb (DB) and 67°F wet bulb (WB) and outdoor ambient conditions of 95°F dry bulb (DB) and 75°F wet bulb (WB).

³ Rated heating capacity obtained with air entering the indoor unit at 70°F dry bulb (DB) and 60°F wet bulb (WB) and outdoor ambient conditions of 47°F dry bulb (DB) and 43°F wet bulb (WB).

For capacity information, see engineering manual capacity tables.

⁴ All power/communication wiring minimum 4-conductor, stranded, shielded, and must comply with applicable local and national codes.

⁵ Installation of an optional Low Ambient Wind Baffle Kit will allow operation down to 0°F in cooling mode for applicable outdoor units.

⁶ Airflow shown is in heating and cooling mode.

⁷ Sound pressure levels are tested in an anechoic chamber under ISO Standard 3745 and are the same in both cooling and heating mode. These values can increase due to ambient conditions during operation.

⁸ Piping lengths are equivalent.

Due to our commitment to continued innovation, some specifications may be changed without notification.

HIGH EFFICIENCY



LG ThinQ®

LS090HSV5
LS120HSV5
LS181HSV5



Specification	Unit	LS090HSV5	LS120HSV5	LS181HSV5
Indoor Unit		LSN090HSV5	LSN120HSV5	LSN181HSV5
Outdoor Unit		LSU090HSV5	LSU120HSV5	LSU181HSV5
Capacity^{1,2}				
Rated Cooling Capacity	Btu/h	9,000	12,000	18,000
Cooling Capacity Range	Btu/h	1,023 - 12,625	1,023 - 13,785	3,070 - 29,515
Rated Heating Capacity	Btu/h	10,900	13,600	21,600
Heating Capacity Range	Btu/h	1,023 - 17,061	1,023 - 22,178	3,070 - 38,898
Max Heating Capacity at 17°F	Btu/h	11,080	13,810	22,340
Max Heating Capacity at 5°F	Btu/h	9,570	11,930	19,300
Max Heating Capacity at -4°F	Btu/h	8,310	10,360	16,760
SEER2, EER2		23.20, 14.50	22.00, 12.50	22.00, 12.55
HSPF2		10.20	10.00	9.50
Power				
Voltage (IDU)	V, Hz, Ø	208/230, 60, 1	208/230, 60, 1	208/230, 60, 1
Voltage (ODU)	V, Hz, Ø	208/230, 60, 1	208/230, 60, 1	208/230, 60, 1
Cooling Power Input	kW	0.62	0.96	1.43
Heating Power Input	kW	0.71	1.04	1.73
MCA, MOCP	A	10.0, 15.0	10.0, 15.0	19.0, 30.0
Power/Communication Wiring ³	No. x AWG	4 x 14	4 x 14	4 x 14
Rated Amps (Cool/Heat)	A	7.80 / 7.80	7.80 / 7.80	13.78 / 15.48
Operation Range				
ODU Heating Operation Range	°F WB	-4 - 65	-4 - 65	-4 - 65
ODU Cooling Operation Range	°F DB	14 - 118	14 - 118	14 - 118
Optional Wind Baffle ⁴		ZLABGP01A (0°F)	ZLABGP01A (0°F)	ZLABGP04A (0°F)
IDU Operation Range Cooling	°F WB	53 - 75	53 - 75	53 - 75
IDU Operation Range Heating	°F DB	60 - 86	60 - 86	60 - 86
Setpoint Range Cooling	°F	64 - 86	64 - 86	64 - 86
Setpoint Range Heating	°F	60 - 86	60 - 86	60 - 86
Dimensions				
IDU Dimensions (WxHxD)	in	32-15/16 x 12-1/8 x 7-7/16	32-15/16 x 12-1/8 x 7-7/16	39-9/32 x 13-19/32 x 8-9/32
ODU Dimensions (WxHxD)	in	30-5/16 x 21-1/2 x 11-5/16	30-5/16 x 21-1/2 x 11-5/16	37-13/32 x 32-3/4 x 13
Weight				
IDU Weight (Net/Shipping)	lbs	18.3 / 23.4	18.3 / 23.4	25.6 / 32.2
ODU Weight (Net/Shipping)	lbs	74.1 / 78.9	74.1 / 78.9	127.9 / 145.5
Unit Data				
Airflow (Max/H/M/L) ⁵	CFM	459 / 338 / 317 / 194	459 / 338 / 317 / 194	706 / 530 / 477 / 371
Dehumidification	pts/hr	2.70	2.70	5.50
Compressor Type		Twin Rotary	Twin Rotary	Twin Rotary
Refrigerant Type		R410A	R410A	R410A
Sound Pressure⁶				
Indoor (H/M/L/SL)	dB(A)	41 / 35 / 25 / 21	41 / 35 / 25 / 21	47 / 42 / 37 / 31
Outdoor Max	dB(A)	51	51	55
Piping⁷				
Liquid Pipe	in	1/4	1/4	3/8
Vapor Pipe	in	3/8	3/8	5/8
Pipe Length (Min/Max)	ft	9.8 / 82	9.8 / 82	9.8 / 114.8
Max Pipe Elevation	ft	49.2	49.2	49.2
Precharge Pipe Length	ft	41.0	41.0	24.6
Additional Refrigerant	oz/ft	0.22	0.22	0.38
Drain (OD, ID)	in	27/32, 5/8	27/32, 5/8	27/32, 5/8
Controller				
Supplied		AKB74955602	AKB74955602	AKB74955602

Note:

¹Rated capacity at 0 ft. above sea level with 25 ft. of refrigerant line and a 0 ft. level difference between outdoor and indoor unit.

²Rated cooling capacity obtained with air entering the indoor unit at 80°F dry bulb (DB) and 67°F wet bulb (WB) and outdoor ambient conditions of 95°F dry bulb (DB) and 75°F wet bulb (WB).
Rated heating capacity obtained with air entering the indoor unit at 70°F dry bulb (DB) and 60°F wet bulb (WB) and outdoor ambient conditions of 47°F dry bulb (DB) and 43°F wet bulb (WB).
For capacity information, see engineering manual capacity tables.

³All power/communication wiring minimum 4-conductor, stranded, shielded, and must comply with applicable local and national codes.

⁴Installation of an optional Low Ambient Wind Baffle Kit will allow operation down to 0°F in cooling mode for applicable outdoor units.

⁵Airflow shown is in heating and cooling mode.

⁶Sound pressure levels are tested in an anechoic chamber under ISO Standard 3745 and are the same in both cooling and heating mode. These values can increase due to ambient conditions during operation.

⁷Piping lengths are equivalent.

Due to our commitment to continued innovation, some specifications may be changed without notification.

STANDARD EFFICIENCY



LS090HFV3
LS120HFV3

LS180HFV3
LS240HFV3



SINGLE-ZONE

WALL MOUNTED

Specification	Unit	LS090HFV3	LS120HFV3	LS180HFV3	LS240HFV3
Indoor Unit		LSN090HFV3	LSN120HFV3	LSN180HFV3	LSN240HFV3
Outdoor Unit		LSU090HFV3	LSU120HFV3	LSU180HFV3	LSU240HFV3
Rated Cooling Capacity	Btu/h	9,000	12,000	18,000	22,000
Cooling Capacity Range	Btu/h	3,070 ~ 10,330	3,070 ~ 13,780	3,685 ~ 18,493	3,685 ~ 24,000
Rated Heating Capacity	Btu/h	10,900	12,000	19,000	22,000
Heating Capacity Range	Btu/h	3,070 ~ 12,520	3,070 ~ 13,780	3,685 ~ 22,997	3,685 ~ 25,260
Max Heating Capacity at 17°F	Btu/h	8,760	9,640	15,270	17,680
SEER2, EER2		17.00, 12.50	17.00, 10.50	17.00, 12.00	17.00, 11.00
HSPF2		8.70	8.50	8.90	8.30
Voltage (IDU)	V, Hz, Ø	208/230, 60, 1	208/230, 60, 1	208/230, 60, 1	208/230, 60, 1
Voltage (ODU)	V, Hz, Ø	208/230, 60, 1	208/230, 60, 1	208/230, 60, 1	208/230, 60, 1
Cooling Power Input	kW	82.00	1.25	1.65	2.20
Heating Power Input	kW	95.00	1.05	1.74	2.03
MCA, MOCP	A	10.0, 15.0	10.0, 15.0	15.0, 20.0	15.0, 20.0
Power/Communication Wiring ³	No. x AWG	4 x 14	4 x 14	4 x 14	4 x 14
Rated Amps Cool/Heat	A	7.80 / 7.80	7.80 / 7.80	10.80 / 10.80	10.80 / 10.80
ODU Heating Operation Range	°F WB	14 ~ 65	14 ~ 65	14 ~ 65	14 ~ 65
ODU Cooling Operation Range	°F DB	14 ~ 118	14 ~ 118	14 ~ 118	14 ~ 118
Optional Wind Baffle ⁴		No	No	No	No
IDU Operation Range Cooling	°F WB	53 ~ 75	53 ~ 75	53 ~ 75	53 ~ 75
IDU Operation Range Heating	°F DB	60 ~ 86	60 ~ 86	60 ~ 86	60 ~ 86
Setpoint Range Cooling	°F	64 ~ 86	64 ~ 86	64 ~ 86	64 ~ 86
Setpoint Range Heating	°F	60 ~ 86	60 ~ 86	60 ~ 86	60 ~ 86
IDU Dimensions (WxHxD)	in	32-15/16 x 12-1/8 x 7-7/16	32-15/16 x 12-1/8 x 7-7/16	39-9/32 x 13-19/32 x 8-9/32	39-9/32 x 13-19/32 x 8-9/32
ODU Dimensions (WxHxD)	in	28-7/32 x 19-1/2 x 9-1/16	28-7/32 x 19-1/2 x 9-1/16	34-1/4 x 25-19/32 x 13	34-1/4 x 25-19/32 x 13
IDU Weight (Net/Shipping)	lbs	19.2 / 25.4	19.2 / 25.4	26.0 / 30.0	26.0 / 30.0
ODU Weight (Net/Shipping)	lbs	55.3 / 60.0	55.3 / 60.0	98.1 / 108.0	98.1 / 108.0
Airflow (H/M/L) ⁵	CFM	459 / 353 / 264 / 148	459 / 353 / 264 / 148	689 / 512 / 459 / 371	689 / 512 / 459 / 371
Dehumidification	pts/hr	2.32	2.75	3.38	4.86
Compressor Type		Twin Rotary	Twin Rotary	Twin Rotary	Twin Rotary
Refrigerant Type		R410A	R410A	R410A	R410A
Indoor (H/M/L/SL)	dB(A)	42/36/28/21	42/36/28/21	48/43/38/32	48/43/38/32
Outdoor Max	dB(A)	50	50	55	55
Liquid Pipe	in	1/4	1/4	1/4	1/4
Vapor Pipe	in	3/8	3/8	1/2	1/2
Pipe Length (Min/Max)	ft	9.8 / 49.2	9.8 / 49.2	9.8 / 65.6	9.8 / 65.6
Max Pipe Elevation	ft	23.0	23.0	32.8	32.8
Precharge Pipe Length	ft	24.6	24.6	24.6	24.6
Additional Refrigerant	oz/ft	0.22	0.22	0.26	0.26
Drain (OD, ID)	in	27/32, 5/8	27/32, 5/8	27/32, 5/8	27/32, 5/8
Controller	Supplied	AKB74955602	AKB74955602	AKB74955602	AKB74955602

Note:

¹Rated capacity at 0 ft. above sea level with 25 ft. of refrigerant line and a 0 ft. level difference between outdoor and indoor unit.

²Rated cooling capacity obtained with air entering the indoor unit at 80 °F dry bulb (DB) and 67 °F wet bulb (WB) and outdoor ambient conditions of 95 °F dry bulb (DB) and 75 °F wet bulb (WB).

Rated heating capacity obtained with air entering the indoor unit at 70 °F dry bulb (DB) and 60 °F wet bulb (WB) and outdoor ambient conditions of 47 °F dry bulb (DB) and 43 °F wet bulb (WB). For capacity information, see engineering manual capacity tables.

³All power/communication wiring minimum 4-conductor, stranded, shielded, and must comply with applicable local and national codes.

⁴Installation of an optional Low Ambient Wind Baffle Kit will allow operation down to 0 °F in cooling mode for applicable outdoor units.

⁵Airflow shown is in heating and cooling mode.

⁶Sound pressure levels are tested in an anechoic chamber under ISO Standard 3745 and are the same in both cooling and heating mode. These values can increase due to ambient conditions during operation.

⁷Piping lengths are equivalent.

Due to our commitment to continued innovation, some specifications may be changed without notification.

MEGA

LS090HEV2
LS090HXV2
LS120HEV2

LS120HXV2
LS180HEV2
LS240HEV2



Specification	Unit	LS090HEV2	LS090HXV2	LS120HEV2	LS120HXV2	LS180HEV2	LS240HEV2
Indoor Unit		LSN090HEV2	LSN090HXV2	LSN120HEV2	LSN120HXV2	LSN180HEV2	LSN240HEV2
Outdoor Unit		LSU090HEV2	LSU090HXV2	LSU120HEV2	LSU120HXV2	LSU180HEV2	LSU240HEV2
Rated Cooling Capacity	Btu/h	9,000	9,000	12,000	12,000	18,000	22,000
Cooling Capacity Range	Btu/h	3,070 - 10,330	3,070 - 10,330	3,070 - 13,780	3,070 - 13,780	3,685 - 18,493	3,685 - 24,000
Rated Heating Capacity	Btu/h	10,900	10,900	12,000	12,000	19,000	22,000
Heating Capacity Range	Btu/h	3,070 - 12,520	3,070 - 12,520	3,070 - 13,780	3,070 - 13,780	3,685 - 22,997	3,685 - 25,260
Max Heating Capacity at 17°F	Btu/h	8,760	8,760	9,640	9,640	15,270	17,680
SEER2, EER2		20.00, 12.50	20.00, 12.30	19.00, 10.50	19.00, 10.50	19.00, 12.0	19.00, 11.00
HSPF2		9.20	9.20	9.00	9.00	9.40	8.80
Voltage (IDU)	V, Hz, Ø	208/230, 60, 1	115, 60, 1	208/230, 60, 1	115, 60, 1	208/230, 60, 1	208/230, 60, 1
Voltage (ODU)	V, Hz, Ø	208/230, 60, 1	115, 60, 1	208/230, 60, 1	115, 60, 1	208/230, 60, 1	208/230, 60, 1
Cooling Power Input	kW	0.72	0.73	1.14	1.14	1.50	2.00
Heating Power Input	kW	0.88	0.88	1.00	1.00	1.58	1.93
MCA, MOCP	A	10.0, 15.0	15.0, 25.0	10.0, 15.0	15.0, 25.0	15.0, 20.0	15.0, 20.0
Power/Communication Wiring ³	No. x AWG	4 x 14	4 x 14	4 x 14	4 x 14	4 x 14	4 x 14
Rated Amps Cool/Heat	A	7.80 / 7.80	11.80 / 11.80	7.80 / 7.80	11.80 / 11.80	10.80 / 10.80	10.80 / 10.80
ODU Heating Operation Range	°F WB	14 - 65	14 - 65	14 - 65	14 - 65	14 - 65	14 - 65
ODU Cooling Operation Range	°F DB	14 - 118	14 - 118	14 - 118	14 - 118	14 - 118	14 - 118
Optional Wind Baffle ⁴		No	No	No	No	No	No
IDU Operation Range Cooling	°F WB	53 - 75	53 - 75	53 - 75	53 - 75	53 - 75	53 - 75
IDU Operation Range Heating	°F DB	60 - 86	60 - 86	60 - 86	60 - 86	60 - 86	60 - 86
Setpoint Range Cooling	°F	64 - 86	64 - 86	64 - 86	64 - 86	64 - 86	64 - 86
Setpoint Range Heating	°F	60 - 86	60 - 86	60 - 86	60 - 86	60 - 86	60 - 86
IDU Dimensions (WxHxD)	in	32-15/16 x 12-1/8 x 7-7/16	32-15/16 x 12-1/8 x 7-7/16	32-15/16 x 12-1/8 x 7-7/16	32-15/16 x 12-1/8 x 7-7/16	39-9/32 x 13-19/32 x 8-9/32	39-9/32 x 13-19/32 x 8-9/32
ODU Dimensions (WxHxD)	in	28-7/32 x 19-1/2 x 9-1/16	28-7/32 x 19-1/2 x 9-1/16	28-7/32 x 19-1/2 x 9-1/16	28-7/32 x 19-1/2 x 9-1/16	34-1/4 x 25-19/32 x 13	34-1/4 x 25-19/32 x 13
IDU Weight (Net/Shipping)	lbs	19.2 / 25.4	19.2 / 22.0	19.2 / 25.4	19.2 / 22.0	26.0 / 30.0	26.0 / 30.0
ODU Weight (Net/Shipping)	lbs	55.3 / 60.0	58.4 / 60.0	55.3 / 60.0	58.4 / 60.0	98.1 / 108.0	98.1 / 108.0
Airflow (H/M/L) ⁵	CFM	459/353/264/148	459/353/264/148	459/353/264/148	459/353/264/148	689/512/459/371	689/512/459/371
Dehumidification	pts/hr	2.32	2.32	2.75	2.75	3.38	4.86
Compressor Type		Twin Rotary	Twin Rotary	Twin Rotary	Twin Rotary	Twin Rotary	Twin Rotary
Refrigerant Type		R410A	R410A	R410A	R410A	R410A	R410A
Indoor (H/M/L/SL)	dB(A)	42 / 36 / 28 / 21	42 / 36 / 28 / 21	42 / 36 / 28 / 21	42 / 36 / 28 / 21	48 / 43 / 38 / 32	48 / 43 / 38 / 32
Outdoor Max	dB(A)	50	50	50	50	55	55
Liquid Pipe	in	1/4	1/4	1/4	1/4	1/4	1/4
Vapor Pipe	in	3/8	3/8	3/8	3/8	1/2	1/2
Pipe Length (Min/Max)	ft	9.8 / 49.2	9.8 / 49.2	9.8 / 49.2	9.8 / 49.2	9.8 / 65.6	9.8 / 65.6
Max Pipe Elevation	ft	23.0	23.0	23.0	23.0	32.8	32.8
Precharge Pipe Length	ft	24.6	24.6	24.6	24.6	24.6	24.6
Additional Refrigerant	oz/ft	0.22	0.22	0.22	0.22	0.26	0.26
Drain (OD, ID)	in	27/32, 5/8	27/32, 5/8	27/32, 5/8	27/32, 5/8	27/32, 5/8	27/32, 5/8
Controller	Supplied	AKB74955602	AKB74955602	AKB74955602	AKB74955602	AKB74955602	AKB74955602

Note:

¹Rated capacity at 0 ft. above sea level with 25 ft. of refrigerant line and a 0 ft. level difference between outdoor and indoor unit.

²Rated cooling capacity obtained with air entering the indoor unit at 80°F dry bulb (DB) and 67°F wet bulb (WB) and outdoor ambient conditions of 95°F dry bulb (DB) and 75°F wet bulb (WB).
Rated heating capacity obtained with air entering the indoor unit at 70°F dry bulb (DB) and 60°F wet bulb (WB) and outdoor ambient conditions of 47°F dry bulb (DB) and 43°F wet bulb (WB).
For capacity information, see engineering manual capacity tables.

³All power/communication wiring minimum 4-conductor, stranded, shielded, and must comply with applicable local and national codes.

⁴Installation of an optional Low Ambient Wind Baffle Kit will allow operation down to 0°F in cooling mode for applicable outdoor units.

⁵Airflow shown is in heating and cooling mode.

⁶Sound pressure levels are tested in an anechoic chamber under ISO Standard 3745 and are the same in both cooling and heating mode. These values can increase due to ambient conditions during operation.

⁷Piping lengths are equivalent.

Due to our commitment to continued innovation, some specifications may be changed without notification.

LOW WALL CONSOLE



LG ThinQ®

LQ090HV
LQ120HV



SINGLE-ZONE

WALL MOUNTED

Specification	Unit	LQ090HV	LQ120HV
Indoor Unit		LQN090HV4	LQN120HV4
Outdoor Unit		LUU090HV	LUU120HV
Rated Cooling Capacity	Btu/h	9,000	10,200
Cooling Capacity Range	Btu/h	4,270 ~ 11,500	4,500 ~ 13,460
Rated Heating Capacity	Btu/h	10,100	13,000
Heating Capacity Range	Btu/h	4,600 ~ 13,000	5,970 ~ 15,000
Capacity ^{1,2}			
Max Heating Capacity at 17°F	Btu/h	10,640	12,080
Max Heating Capacity at 5°F	Btu/h	10,200	10,800
Max Heating Capacity at -4°F	Btu/h	9,380	9,960
SEER2, EER2		21.00, 12.60	20.80, 12.60
HSPF2		10.40	10.20
Power			
Voltage (IDU)	V, Hz, Ø	208/230, 60, 1	208/230, 60, 1
Voltage (ODU)	V, Hz, Ø	208/230, 60, 1	208/230, 60, 1
Cooling Power Input	kW	0.71	0.81
Heating Power Input	kW	0.85	1.23
MCA, MOCP	A	11.9, 15.0	12.3, 15.0
Power/Communication Wiring ³	No. x AWG	4 x 14	4 x 14
Rated Amps Cool/Heat	A	9.95 / 9.95	9.95 / 9.95
Operating Range			
ODU Heating Operation Range	°F WB	-4 ~ 64	-4 ~ 64
ODU Cooling Operation Range	°F DB	0 ~ 118	0 ~ 118
Optional Wind Baffle ⁴	Yes	ZLABGP01A (-4°F)	ZLABGP01A (-4°F)
IDU Operation Range Cooling	°F WB	57 ~ 77	57 ~ 77
IDU Operation Range Heating	°F DB	59 ~ 81	59 ~ 81
Setpoint Range Cooling	°F	65 ~ 86	65 ~ 86
Setpoint Range Heating	°F	61 ~ 86	61 ~ 86
Dimensions			
IDU Dimensions (WxHxD)	in	27-9/16 x 23-5/8 x 8-9/32	27-9/16 x 23-5/8 x 8-9/32
ODU Dimensions (WxHxD)	in	30-5/16x21-15/32x11-11/32	30-5/16x21-15/32x11-11/32
Weight			
IDU Weight (Net/Shipping)	lbs	35.7 / 42.5	35.7 / 42.5
ODU Weight (Net/Shipping)	lbs	71.0 / 76.0	71.0 / 76.0
Airflow (Max/H/M/L) ⁵	CFM	318/300/237/177	353/318/244/184
Unit Data			
Dehumidification	pts/hr	2.00	2.50
Compressor Type		Twin Rotary	Twin Rotary
Refrigerant Type		R410A	R410A
Sound Pressure ⁶			
Indoor (H/M/L)	dB(A)	38 / 32 / 27	39 / 32 / 27
Outdoor Max	dB(A)	51	52
Piping ⁷			
Liquid Pipe	in	1/4	1/4
Vapor Pipe	in	3/8	3/8
Pipe Length (Min/Std/Max)	ft	16.4 / 25.0 / 66.0	16.4 / 25.0 / 66.0
Max Pipe Elevation	ft	49.0	49.0
Precharge Pipe Length	ft	24.6	24.6
Additional Refrigerant	oz/ft	0.22	0.22
Drain (OD, ID)	in	1-1/4, 1	1-1/4, 1
Controller	Supplied	AKB75735410	AKB75735410

Note:

¹Rated capacity at 0 ft. above sea level with 25 ft. of refrigerant line and a 0 ft. level difference between outdoor and indoor unit.

²Rated cooling capacity obtained with air entering the indoor unit at 80°F dry bulb (DB) and 67°F wet bulb (WB) and outdoor ambient conditions of 95°F dry bulb (DB) and 75°F wet bulb (WB).
³Rated heating capacity obtained with air entering the indoor unit at 70°F dry bulb (DB) and 60°F wet bulb (WB) and outdoor ambient conditions of 47°F dry bulb (DB) and 43°F wet bulb (WB).
 For capacity information, see engineering manual capacity tables.

⁴All power/communication wiring minimum 4-conductor, stranded, shielded, and must comply with applicable local and national codes.

⁵Installation of an optional Low Ambient Wind Baffle Kit will allow operation down to 0°F in cooling mode for applicable outdoor units.

⁶Airflow shown is in heating and cooling mode.

⁷Sound pressure levels are tested in an anechoic chamber under ISO Standard 3745 and are the same in both cooling and heating mode. These values can increase due to ambient conditions during operation.

⁸Piping lengths are equivalent.

Due to our commitment to continued innovation, some specifications may be changed without notification.

4-WAY CASSETTE (2x2)



LC098HV
LC128HV

LC188HV



Specification	Unit	LC098HV	LC128HV	LC188HV
Indoor Unit		LCN098HV4	LCN128HV4	LCN188HV4
Outdoor Unit		LUU090HV	LUU120HV	LUU180HV
Capacity^{1,2}				
Rated Cooling Capacity	Btu/h	9,000	11,100	18,000
Cooling Capacity Range	Btu/h	3,600 - 9,900	3,400 - 12,400	7,700 - 24,800
Rated Heating Capacity	Btu/h	11,000	14,000	18,500
Heating Capacity Range	Btu/h	4,400 - 12,100	2,800 - 15,500	6,500 - 23,400
Max Heating Capacity at 17°F	Btu/h	11,000	11,900	17,000
Max Heating Capacity at 5°F	Btu/h	10,100	10,700	16,200
Max Heating Capacity at -4°F	Btu/h	9,040	9,280	15,250
SEER2, EER2		20.20, 13.65	19.40, 12.60	20.50, 12.50
HSPF2		10.55	10.35	9.70
Power				
Voltage (IDU)	V, Hz, Ø	208/230, 60, 1	208/230, 60, 1	208/230, 60, 1
Voltage (ODU)	V, Hz, Ø	208/230, 60, 1	208/230, 60, 1	208/230, 60, 1
Cooling Power Input	kW	0.66	0.88	1.44
Heating Power Input	kW	0.83	1.19	1.95
MCA, MOCP	A	11.9, 15.0	12.3, 15.0	20.0, 30.0
Power/Communication Wiring ³	No. x AWG	4 x 14	4 x 14	4 x 14
Rated Amps Cool/Heat	A	9.65 / 9.65	10.05 / 10.05	15.35 / 15.35
Operating Range				
ODU Heating Operation Range	°F WB	-4 - 64	-4 - 64	-4 - 64
ODU Cooling Operation Range	°F DB	0 - 118	0 - 118	5 - 118
Optional Wind Baffle ⁴	Yes	ZLABGP01A (-4 °F)	ZLABGP01A (-4 °F)	ZLABGP04A (-4 °F)
IDU Operation Range Cooling	°F WB	57 - 77	57 - 77	57 - 77
IDU Operation Range Heating	°F DB	59 - 81	59 - 81	59 - 81
Setpoint Range Cooling	°F	65 - 86	65 - 86	65 - 86
Setpoint Range Heating	°F	61 - 86	61 - 86	61 - 86
Dimensions				
IDU Dimensions (WxHxD)	in	22-7/16 x 8-7/64 x 22-7/16	22-7/16 x 8-7/64 x 22-7/16	22-7/16 x 10 5/64 x 22-7/16
ODU Dimensions (WxHxD)	in	30-5/16 x 21-15/32 x 11-11/32	30-5/16 x 21-15/32 x 11-11/32	37-13/32 x 32-27/32 x 13
Weight				
IDU Weight (Net/Shipping)	lbs	31.0 / 37.0	31.0 / 37.0	32.0 / 40.0
ODU Weight (Net/Shipping)	lbs	71.0 / 76.0	71.0 / 76.0	130.1 / 147.7
Unit Data				
Airflow (Max/H/M/L) ⁵	CFM	300 / 265 / 230	335 / 283 / 247	460 / 424 / 388
Dehumidification	pts/hr	1.60	2.47	3.30
Compressor Type		Twin Rotary	Twin Rotary	Twin Rotary
Refrigerant Type		R410A / EEV	R410A / EEV	R410A / EEV
Sound Pressure⁶				
Indoor (H/M/L)	dB(A)	36 / 33 / 30	38 / 35 / 32	43 / 41 / 38
Outdoor Max (Cool/Heat)	dB(A)	47 / 51	49 / 52	48 / 52
Piping⁷				
Liquid Pipe	in	1/4	1/4	3/8
Vapor Pipe	in	3/8	3/8	5/8
Pipe Length (Min/Max)	ft	16.4 / 66.0	16.4 / 66.0	16.4 / 164.0
Max Pipe Elevation	ft	49.0	49.0	98.4
Precharge Pipe Length	ft	24.6	24.6	24.6
Additional Refrigerant	oz/ft	0.22	0.22	0.43
Drain (OD, ID)	in	1-1/4, 1	1-1/4, 1	1-1/4, 1
Controller				
Supplied		PWLSSB21H	PWLSSB21H	PWLSSB21H
Grille		PT-QAGW0	PT-QAGW0	PT-QAGW0
Accessories				
Grille Weight (Net/Shipping)	lbs	7 / 9	7 / 9	7 / 9

Note:

¹Rated capacity at 0 ft. above sea level with 25 ft. of refrigerant line and a 0 ft. level difference between outdoor and indoor unit.

²Rated cooling capacity obtained with air entering the indoor unit at 80 °F dry bulb (DB) and 67 °F wet bulb (WB) and outdoor ambient conditions of 95 °F dry bulb (DB) and 75 °F wet bulb (WB).
³Rated heating capacity obtained with air entering the indoor unit at 70 °F dry bulb (DB) and 60 °F wet bulb (WB) and outdoor ambient conditions of 47 °F dry bulb (DB) and 43 °F wet bulb (WB).
 For capacity information, see engineering manual capacity tables.

⁴All power/communication wiring minimum 4-conductor, stranded, shielded, and must comply with applicable local and national codes.

⁵Installation of an optional Low Ambient Wind Baffle Kit will allow operation down to 0 °F in cooling mode for applicable outdoor units.

⁶Airflow shown is in heating and cooling mode.

⁷Sound pressure levels are tested in an anechoic chamber under ISO Standard 3745 and are the same in both cooling and heating mode. These values can increase due to ambient conditions during operation.

⁸Piping lengths are equivalent.

Due to our commitment to continued innovation, some specifications may be changed without notification.

4-WAY CASSETTE (2x2) with LGRED°

LC188HHV4

SINGLE-ZONE



LGRED°



Specification	Unit	LC188HHV4
Indoor Unit		LCN188HV4
Outdoor Unit		LUU180HHV
Rated Cooling Capacity	Btu/h	18,000
Cooling Capacity Range	Btu/h	7,200 ~ 24,800
Rated Heating Capacity	Btu/h	20,000
Heating Capacity Range	Btu/h	6,500 ~ 23,700
Max Heating Capacity at 17°F	Btu/h	22,500
Max Heating Capacity at 5°F	Btu/h	17,600
Max Heating Capacity at -4°F	Btu/h	17,920
SEER2, EER2		20.00, 12.80
HSPF2		9.40
Voltage (IDU)	V, Hz, Ø	208/230, 60, 1
Voltage (ODU)	V, Hz, Ø	208/230, 60, 1
Cooling Power Input	kW	1.41
Heating Power Input	kW	1.80
MCA, MOCP	A	22.0, 30.0
Power/Communication Wiring ³	No. x AWG	4 x 14
Rated Amps Cool/Heat	A	16.70 / 16.70
ODU Heating Operation Range	°F WB	-13 ~ 64
ODU Cooling Operation Range	°F DB	5 ~ 118
Optional Wind Baffle ⁴	Yes	ZLABGP04A (-4°F)
IDU Operation Range Cooling	°F WB	57 ~ 77
IDU Operation Range Heating	°F DB	59 ~ 81
Setpoint Range Cooling	°F	65 ~ 86
Setpoint Range Heating	°F	61 ~ 86
IDU Dimensions (WxHxD)	in	22-7/16 x 11 x 22-7/16
ODU Dimensions (WxHxD)	in	37-13/32 x 32-27/32 x 13
IDU Weight (Net/Shipping)	lbs	31.5 / 40.0
ODU Weight (Net/Shipping)	lbs	133.4 / 144.4
Airflow (Max/H/M/L) ⁵	CFM	494 / 460 / 424 / 388
Dehumidification	pts/hr	4.28
Compressor Type		R1 Scroll
Refrigerant Type		R410A / EEV
Indoor (H/M/L/SL)	dB(A)	41 / 39 / 36 / 33
Outdoor Max (Cool/Heat)	dB(A)	51 / 52
Liquid Pipe	in	3/8
Vapor Pipe	in	5/8
Pipe Length (Min/Max)	ft	16.4/164
Max Pipe Elevation	ft	98.4
Precharge Pipe Length	ft	24.9
Additional Refrigerant	oz/ft	0.43
Drain (OD, ID)	in	1-1/4, 1
Supplied		PWLSSB21H
Grille		PT-QAGWO
Grille Weight (Net/Shipping)	lbs	7 / 9

Note:

¹Rated capacity at 0 ft. above sea level with 25 ft. of refrigerant line and a 0 ft. level difference between outdoor and indoor unit.

²Rated cooling capacity obtained with air entering the indoor unit at 80 °F dry bulb (DB) and 67 °F wet bulb (WB) and outdoor ambient conditions of 95 °F dry bulb (DB) and 75 °F wet bulb (WB).

³Rated heating capacity obtained with air entering the indoor unit at 70 °F dry bulb (DB) and 60 °F wet bulb (WB) and outdoor ambient conditions of 47 °F dry bulb (DB) and 43 °F wet bulb (WB). For capacity information, see engineering manual capacity tables.

⁴All power/communication wiring minimum 4-conductor, stranded, shielded, and must comply with applicable local and national codes.

⁵Installation of an optional Low Ambient Wind Baffle Kit will allow operation down to 0 °F in cooling mode for applicable outdoor units.

⁶Airflow shown is in heating and cooling mode.

⁷Sound pressure levels are tested in an anechoic chamber under ISO Standard 3745 and are the same in both cooling and heating mode. These values can increase due to ambient conditions during operation.

⁸Piping lengths are equivalent.

Due to our commitment to continued innovation, some specifications may be changed without notification.

4-WAY CASSETTE (3×3)



LC249HV

LC369HV
LC429HV

Specification	Unit	LC249HV	LC369HV	LC429HV
Indoor Unit		LCN249HV	LCN369HV	LCN429HV
Outdoor Unit		LUU240HV	LUU360HV	LUU420HV
Rated Cooling Capacity	Btu/h	23,000	36,000	42,000
Cooling Capacity Range	Btu/h	9,600 – 28,000	14,400 – 42,000	16,800 – 48,700
Rated Heating Capacity	Btu/h	27,000	40,000	47,000
Heating Capacity Range	Btu/h	10,800 – 30,000	16,000 – 42,200	18,000 – 49,800
Capacity ^{1,2}				
Max Heating Capacity at 17°F	Btu/h	26,000	38,000	41,500
Max Heating Capacity at 5°F	Btu/h	21,200	35,000	39,000
Max Heating Capacity at -4°F	Btu/h	20,760	31,450	38,230
SEER2, EER2		20.00, 11.70	21.00, 12.50	19.30, 10.45
HSPF2		10.20	10.00	10.05
Power				
Voltage (IDU)	V, Hz, Ø	208/230, 60, 1	208/230, 60, 1	208/230, 60, 1
Voltage (ODU)	V, Hz, Ø	208/230, 60, 1	208/230, 60, 1	208/230, 60, 1
Cooling Power Input	kW	1.96	2.88	4.01
Heating Power Input	kW	2.25	3.26	3.63
MCA, MOCP	A	20.0, 30.0	32.0, 40.0	32.0, 40.0
Power/Communication Wiring ³	No. x AWG	4 x 14	4 x 14	4 x 14
Rated Amps Cool/Heat	A	15.70 / 15.70	26.30 / 26.30	26.30 / 26.30
Operating Range				
ODU Heating Operation Range	°F WB	-4 – 64	-4 – 64	-4 – 64
ODU Cooling Operation Range ⁴	°F DB	5 – 118	5 – 118	5 – 118
Optional Wind Baffle ⁴	Yes	ZLABGP04A (-4 °F)	ZLABGP04A x2 (-4 °F)	ZLABGP04A x2 (-4 °F)
IDU Operation Range Cooling	°F WB	57 – 77	57 – 77	57 – 77
IDU Operation Range Heating	°F DB	59 – 81	59 – 81	59 – 81
Setpoint Range Cooling	°F	65 – 86	65 – 86	65 – 86
Setpoint Range Heating	°F	61 – 86	61 – 86	61 – 86
Dimensions				
IDU Dimensions (WxHxD)	in	33-1/16 x 8-1/32 x 33-1/16	33-1/16 x 11-5/16 x 33-1/16	33-1/16 x 11-5/16 x 33-1/16
ODU Dimensions (WxHxD)	in	37-13/32 x 32-27/32 x 13	37-13/32 x 54-11/32 x 13	37-13/32 x 54-11/32 x 13
Weight				
IDU Weight (Net/Shipping)	lbs	45.9 / 54.9	56.4 / 67.7	60.2 / 70.5
ODU Weight (Net/Shipping)	lbs	130.1 / 147.7	193.1 / 217.4	193.1 / 217.4
Unit Data				
Airflow (Max/H/M/L) ⁵	CFM	794 / 671 / 600 / 530	1,200 / 971 / 883 / 794	1,483 / 1,130 / 953 / 812
Dehumidification	pts/hr	3.80	7.10	7.27
Compressor Type		Twin Rotary x 1	Scroll x 1	Scroll x 1
Refrigerant Type		R410A / EEV	R410A / EEV	R410A / EEV
Sound Pressure ⁶				
Indoor (H/M/L/SL)	dB(A)	40 / 37 / 35 / 32	44 / 42 / 41 / 40	46 / 43 / 41 / 39
Outdoor Max (Cool/Heat)	dB(A)	48 / 52	52 / 54	52 / 54
Piping ⁷				
Liquid Pipe	in	3/8	3/8	3/8
Vapor Pipe	in	5/8	5/8	5/8
Pipe Length (Min/Std/Max)	ft	16.4 / 164	16.4 / 246	16.4 / 246
Max Pipe Elevation	ft	98.4	98.4	98.4
Precharge Pipe Length	ft	24.6	24.6	24.6
Additional Refrigerant	oz/ft	0.43	0.43	0.43
Drain (OD, ID)	in	1-1/4, 1	1-1/4, 1	1-1/4, 1
Controller				
Supplied		AKB75735404	AKB75735404	AKB75735404
Grille		PT-AAGW0	PT-AAGW0	PT-AAGW0
Accessories				
Grille Weight (Net/Shipping)	lbs	15.6/20.5	15.6/20.5	15.6/20.5

Note:

¹ Rated capacity at 0 ft. above sea level with 24.6 ft. of refrigerant line and a 0 ft. level difference between outdoor and indoor unit.² Rated cooling capacity obtained with air entering the indoor unit at 80 °F dry bulb (DB) and 67 °F wet bulb (WB) and outdoor ambient conditions of 95 °F dry bulb (DB) and 75 °F wet bulb (WB).³ Rated heating capacity obtained with air entering the indoor unit at 70 °F dry bulb (DB) and 60 °F wet bulb (WB) and outdoor ambient conditions of 47 °F dry bulb (DB) and 43 °F wet bulb (WB). For capacity information, see engineering manual capacity tables.⁴ All power wiring/communication cables from ODU to IDU are field supplied and are to be minimum 14 AWG, 4-conductor, stranded, shielded or unshielded (if shielded, must be grounded to chassis at ODU only), and must comply with applicable local and national codes.⁵ Cooling range can be extended from 5°F down to -4°F using the Low Ambient Wind Baffle Kit (sold separately).⁶ Airflow shown is in heating and cooling mode.⁷ Sound pressure levels are tested in an anechoic chamber under ISO Standard 3745 and are the same in both cooling and heating mode. These values can increase due to ambient conditions during operation.⁸ Piping lengths are equivalent.

Due to our commitment to continued innovation, some specifications may be changed without notification.

4-WAY CASSETTE (3×3) with LGRED°



LGRED°

LC249HHV

LC369HHV
LC429HHV
LC489HHV



Specification	Unit	LC249HHV	LC369HHV	LC429HHV	LC489HHV	
Indoor Unit		LCN249HV	LCN369HV	LCN429HV	LCN489HV	
Outdoor Unit		LUU240HHV	LUU360HHV	LUU420HHV	LUU480HHV	
Rated Cooling Capacity	Btu/h	24,000	36,000	42,000	48,000	
Cooling Capacity Range	Btu/h	9,600 - 30,000	14,400 - 46,000	16,800 - 49,000	19,200 - 53,000	
Rated Heating Capacity	Btu/h	27,000	40,000	48,000	52,000	
Heating Capacity Range	Btu/h	10,800 - 33,000	16,000 - 46,000	18,000 - 57,600	19,000 - 61,000	
Capacity ^{1,2}	Max Heating Capacity at 17°F	Btu/h	28,700	41,700	50,700	54,500
	Max Heating Capacity at 5°F	Btu/h	27,600	40,000	40,000	40,500
	Max Heating Capacity at -4°F	Btu/h	24,410	35,970	42,970	43,740
	SEER2, EER2	21.00, 12.60	21.50, 12.60	19.50, 12.80	17.50, 12.50	
	HSPF2	10.20	10.55	10.75	10.65	
Power	Voltage (IDU)	V, Hz, Ø	208/230, 60, 1	208/230, 60, 1	208/230, 60, 1	208/230, 60, 1
	Voltage (ODU)	V, Hz, Ø	208/230, 60, 1	208/230, 60, 1	208/230, 60, 1	208/230, 60, 1
	Cooling Power Input	kW	1.91	2.86	3.28	3.84
	Heating Power Input	kW	2.25	3.20	3.41	3.85
	MCA, MOCP	A	22.0, 30.0	32.0, 40.0	32.0, 40.0	32.0, 40.0
	Power/Communication Wiring ³	No. x AWG	4 x 14	4 x 14	4 x 14	4 x 14
	Rated Amps Cool/Heat	A	16.70 / 16.70	26.20 / 26.20	26.50 / 26.50	26.50 / 26.50
Operating Range	ODU Heating Operation Range	°F WB	-13 - 64	-13 - 64	-13 - 64	-13 - 64
	ODU Cooling Operation Range	°F DB	5 - 118	5 - 118	5 - 118	5 - 118
	Optional Wind Baffle ⁴	Yes	ZLABGP04A (-4 °F)	ZLABGP04A x2 (-4 °F)	ZLABGP04A x2 (-4 °F)	ZLABGP04A x2 (-4 °F)
	IDU Operation Range Cooling	°F WB	57 - 77	57 - 77	57 - 77	57 - 77
	IDU Operation Range Heating	°F DB	59 - 81	59 - 81	59 - 81	59 - 81
	Setpoint Range Cooling	°F	60 - 86	60 - 86	60 - 86	60 - 86
	Setpoint Range Heating	°F	60 - 86	60 - 86	60 - 86	60 - 86
Dimensions	IDU Dimensions (WxHxD)	in	33-3/32 x 8-1/32 x 33-3/32	33-3/32 x 11-11/32 x 33-3/32	33-3/32 x 11-11/32 x 33-3/32	33-3/32 x 11-11/32 x 33-3/32
	ODU Dimensions (WxHxD)	in	37-13/32 x 32-27/32 x 13	37-13/32 x 54-11/32 x 13	37-13/32 x 54-11/32 x 13	37-13/32 x 54-11/32 x 13
Weight	IDU Weight (Net/Shipping)	lbs	45.2 / 54.9	55.8 / 67.7	59.5 / 70.5	59.5 / 70.5
	ODU Weight (Net/Shipping)	lbs	133.4 / 144.4	198.9 / 223.1	210.9 / 234.1	210.9 / 234.1
Unit Data	Airflow (Max/H/M/L) ⁵	CFM	794 / 671 / 600 / 530	1,200 / 971 / 883 / 794	1,483 / 1,130 / 953 / 812	1,483 / 1,130 / 953 / 812
	Dehumidification	pts/hr	3.80	7.10	7.27	9.74
	Compressor Type		R1 Scroll	R1 Scroll	R1 Scroll	R1 Scroll
	Refrigerant Type		R410A / EEV	R410A / EEV	R410A / EEV	R410A / EEV
Sound Pressure ⁶	Indoor (H/M/L/SL)	dB(A)	40 / 37 / 35 / 32	44 / 42 / 41 / 40	46 / 43 / 41 / 39	46 / 43 / 41 / 39
	Outdoor Max (Cool/Heat)	dB(A)	51 / 52	52 / 54	54 / 56	54 / 56
Piping ⁷	Liquid Pipe	in	3/8	3/8	3/8	3/8
	Vapor Pipe	in	5/8	5/8	5/8	5/8
	Pipe Length (Min/Std/Max)	ft	16.4 / 164	16.4 / 246	16.4 / 246	16.4 / 246
	Max Pipe Elevation	ft	98.4	98.4	98.4	98.4
	Precharge Pipe Length	ft	24.9	24.9	24.9	24.9
	Additional Refrigerant	oz/ft	0.43	0.43	0.43	0.43
	Drain (OD, ID)	in	1-1/4, 1	1-1/4, 1	1-1/4, 1	1-1/4, 1
Controller	Supplied		PWLSSB21H	PWLSSB21H	PWLSSB21H	PWLSSB21H
Accessories	Grille		PT-AAGWO	PT-AAGWO	PT-AAGWO	PT-AAGWO
	Grille Weight (Net/Shipping)	lbs	15.6/20.5	15.6/20.5	15.6/20.5	15.6/20.5

Note:

¹Rated capacity at 0 ft. above sea level with 25 ft. of refrigerant line and a 0 ft. level difference between outdoor and indoor unit.

²Rated cooling capacity obtained with air entering the indoor unit at 80°F dry bulb (DB) and 67°F wet bulb (WB) and outdoor ambient conditions of 95°F dry bulb (DB) and 75°F wet bulb (WB).

Rated heating capacity obtained with air entering the indoor unit at 70°F dry bulb (DB) and 60°F wet bulb (WB) and outdoor ambient conditions of 47°F dry bulb (DB) and 43°F wet bulb (WB). For capacity information, see engineering manual capacity tables.

³All power/communication wiring minimum 4-conductor, stranded, shielded, and must comply with applicable local and national codes.

⁴Installation of an optional Low Ambient Wind Baffle Kit will allow operation down to 0°F in cooling mode for applicable outdoor units.

⁵Airflow shown is in heating and cooling mode.

⁶Sound pressure levels are tested in an anechoic chamber under ISO Standard 3745 and are the same in both cooling and heating mode. These values can increase due to ambient conditions during operation.

⁷Piping lengths are equivalent.

Due to our commitment to continued innovation, some specifications may be changed without notification.

CONVERTIBLE MID STATIC DUCTED



LG ThinQ®

LH098HV1
LH128HV1
LH188HV1
LH248HV1



This unit is convertible using the
Vertical Installation Conversion Kit.

Specification	Unit	LH098HV1	LH128HV1	LH188HV1	LH248HV1
Indoor Unit		LHN098HV1	LHN128HV1	LHN188HV1	LHN248HV1
Outdoor Unit		LUU090HV	LUU120HV	LUU180HV	LUU240HV
Rated Cooling Capacity	Btu/h	9,000	12,000	18,000	23,000
Cooling Capacity Range	Btu/h	3,600 ~ 10,700	4,640 ~ 14,000	7,400 ~ 21,100	9,600 ~ 27,000
Rated Heating Capacity	Btu/h	13,500	15,000	20,000	27,000
Heating Capacity Range	Btu/h	5,600 ~ 16,000	6,400 ~ 17,800	6,800 ~ 21,800	10,800 ~ 30,000
Capacity ^{1,2}					
Max Heating Capacity at 17°F	Btu/h	11,700	13,100	21,300	27,800
Max Heating Capacity at 5°F	Btu/h	11,000	11,000	16,000	24,000
Max Heating Capacity at -4°F	Btu/h	10,260	9,410	12,340	21,010
SEER2, EER2		16.00, 11.80	16.00, 11.70	17.80, 12.60	18.50, 11.80
HSPF2		10.50	10.50	9.90	10.40
Power					
Voltage (IDU)	V, Hz, Ø	208/230, 60, 1	208/230, 60, 1	208/230, 60, 1	208/230, 60, 1
Voltage (ODU)	V, Hz, Ø	208/230, 60, 1	208/230, 60, 1	208/230, 60, 1	208/230, 60, 1
Cooling Power Input	kW	0.76	1.03	1.43	1.95
Heating Power Input	kW	1.06	1.27	1.62	2.10
MCA, MOCP	A	11.9, 15.0	12.3, 15.0	20.0, 30.0	20.0, 30.0
Power/Communication Wiring ³	No. x AWG	4 x 14	4 x 14	4 x 14	4 x 14
Rated Amps Cool/Heat	A	10.95 / 10.95	10.95 / 10.95	16.80 / 16.80	16.80 / 16.80
Operating Range					
ODU Heating Operation Range	°F WB	-4 ~ 64	-4 ~ 64	-4 ~ 64	-4 ~ 64
ODU Cooling Operation Range	°F DB	0 ~ 118	0 ~ 118	5 ~ 118	5 ~ 118
Optional Wind Baffle ⁴		ZLABGP01A (-4°F)	ZLABGP01A (-4°F)	ZLABGP04A (-4°F)	ZLABGP04A (-4°F)
IDU Operation Range Cooling	°F WB	57 ~ 77	57 ~ 77	57 ~ 77	57 ~ 77
IDU Operation Range Heating	°F DB	59 ~ 81	59 ~ 81	59 ~ 81	59 ~ 81
Setpoint Range Cooling	°F	65 ~ 86	65 ~ 86	65 ~ 86	65 ~ 86
Setpoint Range Heating	°F	61 ~ 86	61 ~ 86	61 ~ 86	61 ~ 86
Dimensions					
IDU Dimensions (WxHxD)	in	35-7/16 x 9-21/32 x 27-9/16	35-7/16 x 9-21/32 x 27-9/16	35-7/16 x 9-21/32 x 27-9/16	35-7/16 x 9-21/32 x 27-9/16
ODU Dimensions (WxHxD)	in	30-5/16 x 21-15/32 x 11-11/32	30-5/16 x 21-15/32 x 11-11/32	37-13/32 x 32-27/32 x 13	37-13/32 x 32-27/32 x 13
Weight					
IDU Weight (Net/Shipping)	lbs	61.5 / 71.7	61.5 / 71.7	61.5 / 71.7	64.2 / 74.3
ODU Weight (Net/Shipping)	lbs	71.0 / 76.0	71.0 / 76.0	130.1 / 147.7	130.1 / 147.7
Unit Data					
Airflow (Max. / H / M / L) ⁵	CFM	353 / 318 / 283	494 / 424 / 353	635 / 530 / 424	706 / 547 / 459
Dehumidification	pts/hr	0.85	1.44	2.75	4.23
Max External Static Pressure	in wg	0.59	0.59	0.59	0.59
Compressor Type		Twin Rotary x 1	Twin Rotary x 1	Twin Rotary x 1	Twin Rotary x 1
Refrigerant Type		R410A	R410A	R410A	R410A
Sound Pressure ⁶					
Indoor (H/M/L)	dB(A)	28 / 27 / 26	31 / 29 / 28	36 / 32 / 29	38 / 33 / 30
Outdoor Max (Cool / Heat)	dB(A)	47 / 51	49 / 52	48 / 52	48 / 52
Piping ⁷					
Liquid Pipe	in	1/4	1/4	3/8	3/8
Vapor Pipe	in	3/8	3/8	5/8	5/8
Pipe Length (Min/Max)	ft	16.4 / 66	16.4 / 66	16.4 / 164	16.4 / 164
Max Pipe Elevation	ft	49.0	49.0	98.4	98.4
Precharge Pipe Length	ft	24.9	24.9	24.9	24.9
Additional Refrigerant	oz/ft	0.22	0.22	0.43	0.43
Drain (OD, ID)	in	1-1/4, 31/32	1-1/4, 31/32	1-1/4, 31/32	1-1/4, 31/32
Controller	Additional Accessory ⁸	Wired Controller	Wired Controller	Wired Controller	Wired Controller

Note:

¹ Rated capacity at 0 ft. above sea level with 24.6 ft. of refrigerant line and a 0 ft. level difference between outdoor and indoor unit.

² Rated cooling capacity obtained with air entering the indoor unit at 80°F dry bulb (DB) and 67°F wet bulb (WB) and outdoor ambient conditions of 95°F dry bulb (DB) and 75°F wet bulb (WB).
Rated heating capacity obtained with air entering the indoor unit at 70°F dry bulb (DB) and 60°F wet bulb (WB) and outdoor ambient conditions of 47°F dry bulb (DB) and 43°F wet bulb (WB).
For capacity information, see engineering manual capacity tables.

³ All power wiring / communication cables from ODU to IDU are field supplied and are to be minimum four-conductor, 14 AWG, stranded, shielded or unshielded (if shielded, it must be grounded to the chassis of ODU only), and must comply with applicable local and national codes.

⁴ Installation of an optional Low Ambient Wind Baffle Kit will allow operation down to -4°F in cooling mode for applicable outdoor units.

⁵ Airflow shown is in heating and cooling mode.

⁶ Sound pressure levels are tested in an anechoic chamber under ISO Standard 3745 and are the same in both cooling and heating mode. These values can increase due to ambient conditions during operation.

⁷ Piping lengths are equivalent.

⁸ All LG wired controls are compatible and can be considered for control.

Due to our commitment to continued innovation, some specifications may be changed without notification.

CONVERTIBLE MID STATIC DUCTED with LGRED[®]



LGRED[®]
LG ThinQ[®]

*This unit is convertible using the
Vertical Installation Conversion Kit.*

LH188HHV1
LH248HHV1



Specification	Unit	LH188HHV1	LH248HHV1
Indoor Unit		LHN188HV1	LHN248HV1
Outdoor Unit		LUU180HHV	LUU240HHV
Rated Cooling Capacity	Btu/h	18,000	23,000
Cooling Capacity Range	Btu/h	7,200 - 22,000	9,200 - 29,500
Rated Heating Capacity	Btu/h	20,000	27,000
Heating Capacity Range	Btu/h	6,800 - 24,000	8,000 - 32,800
Capacity ^{1,2}			
Max Heating Capacity at 17°F	Btu/h	21,700	29,500
Max Heating Capacity at 5°F	Btu/h	17,000	27,500
Max Heating Capacity at -13°F	Btu/h	10,740	23,140
SEER2, EER2		17.50, 12.30	16.75, 11.80
HSPF2		9.20	9.40
Power			
Voltage (IDU)	V, Hz, Ø	208/230, 60, 1	208/230, 60, 1
Voltage (ODU)	V, Hz, Ø	208/230, 60, 1	208/230, 60, 1
Cooling Power Input	kW	1.46	1.95
Heating Power Input	kW	1.57	2.25
MCA, MOCP	A	22.0, 30.0	22.0, 30.0
Power/Communication Wiring ³	No. x AWG	4 x 14	4 x 14
Rated Amps Cool/Heat	A	17.80 / 17.80	17.80 / 17.80
Operating Range			
ODU Heating Operation Range	°F WB	-13 - 64	-13 - 64
ODU Cooling Operation Range	°F DB	5 - 118	5 - 118
Optional Wind Baffle ⁴		ZLABGP04A (-4°F)	ZLABGP04A (-4°F)
IDU Operation Range Cooling	°F WB	57 - 77	57 - 77
IDU Operation Range Heating	°F DB	59 - 81	59 - 81
Setpoint Range Cooling	°F	65 - 86	65 - 86
Setpoint Range Heating	°F	61 - 86	61 - 86
Dimensions			
IDU Dimensions (WxHxD)	in	35-7/16 x 9-21/32 x 27-9/16	35-7/16 x 9-21/32 x 27-9/16
ODU Dimensions (WxHxD)	in	37-13/32 x 32-27/32 x 13	37-13/32 x 32-27/32 x 13
Weight			
IDU Weight (Net/Shipping)	lbs	61.5 / 71.7	64.2 / 74.3
ODU Weight (Net/Shipping)	lbs	133.4 / 144.4	133.4 / 144.4
Airflow (Max. / H / M / L) ⁵	CFM	636 / 530 / 424	706 / 547 / 459
Unit Data			
Dehumidification	pts/hr	2.75	4.23
Max External Static Pressure	in wg	0.59	0.59
Compressor Type		R1 Scroll x 1	R1 Scroll x 1
Refrigerant Type		R410A	R410A
Sound Pressure ⁶			
Indoor (H/M/L)	dB(A)	36 / 32 / 29	38 / 33 / 30
Outdoor Max (Cool / Heat)	dB(A)	51 / 52	51 / 52
Piping ⁷			
Liquid Pipe	in	3/8	3/8
Vapor Pipe	in	5/8	5/8
Pipe Length (Min/Max)	ft	16.4 / 164	16.4 / 164
Max Pipe Elevation	ft	98.4	98.4
Precharge Pipe Length	ft	24.9	24.9
Additional Refrigerant	oz/ft	0.43	0.43
Drain (OD, ID)	in	1-1/4, 31/32	1-1/4, 31/32
Controller	Additional Accessory ⁸	Wired Controller	Wired Controller

Note:

¹Rated capacity at 0 ft. above sea level with 24.6 ft. of refrigerant line and a 0 ft. level difference between outdoor and indoor unit.

²Rated cooling capacity obtained with air entering the indoor unit at 80°F dry bulb (DB) and 67°F wet bulb (WB) and outdoor ambient conditions of 95°F dry bulb (DB) and 75°F wet bulb (WB).
Rated heating capacity obtained with air entering the indoor unit at 70°F dry bulb (DB) and 60°F wet bulb (WB) and outdoor ambient conditions of 47°F dry bulb (DB) and 43°F wet bulb (WB).
For capacity information, see engineering manual capacity tables.

³All power wiring / communication cables from ODU to IDU are field supplied and are to be minimum four-conductor, 14 AWG, stranded, shielded or unshielded (if shielded, it must be grounded to the chassis of ODU only), and must comply with applicable local and national codes.

⁴Installation of an optional Low Ambient Wind Baffle Kit will allow operation down to -4°F in cooling mode for applicable outdoor units.

⁵Airflow shown is in heating and cooling mode.

⁶Sound pressure levels are tested in an anechoic chamber under ISO Standard 3745 and are the same in both cooling and heating mode. These values can increase due to ambient conditions during operation.

⁷Piping lengths are equivalent.

⁸All LG wired controls are compatible and can be considered for control.

Due to our commitment to continued innovation, some specifications may be changed without notification.

HIGH STATIC DUCTED

LH368HV



LG ThinQ®



Specification	Unit	LH248HV	LH368HV
Indoor Unit		LHN248HV	LHN368HV
Outdoor Unit		LUU240HV	LUU360HV
Rated Cooling Capacity	Btu/h	24,000	36,000
Cooling Capacity Range	Btu/h	9,600 - 27,000	14,400 - 41,400
Rated Heating Capacity	Btu/h	27,000	40,000
Heating Capacity Range	Btu/h	10,800 - 30,000	16,000 - 42,200
Capacity^{1,2}			
Max Heating Capacity at 17°F	Btu/h	26,000	41,500
Max Heating Capacity at 5°F	Btu/h	21,400	33,600
Max Heating Capacity at -4°F	Btu/h	20,760	27,310
SEER2, EER2		16.85, 11.70	18.85, 11.85
HSPF2		9.00	9.20
Power			
Voltage (IDU)	V, Hz, Ø	208/230, 60, 1	208/230, 60, 1
Voltage (ODU)	V, Hz, Ø	208/230, 60, 1	208/230, 60, 1
Cooling Power Input	kW	2.05	3.04
Heating Power Input	kW	2.26	3.37
MCA, MOCP	A	20.0, 30.0	32.0, 40.0
Power/Communication Wiring ³	No. x AWG	4 x 14	4 x 14
Rated Amps Cool/Heat	A	16.70 / 16.70	27.50 / 27.50
Operating Range			
ODU Heating Operation Range	°F WB	-4 - 64	-4 - 64
ODU Cooling Operation Range	°F DB	5 - 118	5 - 118
Optional Wind Baffle ⁴		ZLABGP04A (-4°F)	ZLABGP04A x 2 (-4°F)
IDU Operation Range Cooling	°F WB	57 - 77	57 - 77
IDU Operation Range Heating	°F DB	59 - 81	59 - 81
Setpoint Range Cooling	°F	65 - 86	65 - 86
Setpoint Range Heating	°F	61 - 86	61 - 86
Dimensions			
IDU Dimensions (WxHxD)	in	35-1/2 x 10-11/16 x 27-1/4	49-9/32 x 10-11/16 x 27-1/4
ODU Dimensions (WxHxD)	in	37-13/32 x 32-27/32 x 13	37-13/32 x 54-11/32 x 13
Weight			
IDU Weight (Net/Shipping)	lbs	58.6 / 71.9	85.3 / 99.4
ODU Weight (Net/Shipping)	lbs	130.1 / 147.7	193.1 / 217.4
Unit Data			
Airflow (H/M/L) ⁵	CFM	777/706/636	1,130/989/848
Dehumidification	pts/hr	5.10	5.90
Max External Static Pressure	in wg	0.59	0.59
Compressor Type		Twin Rotary	R1 Scroll
Refrigerant Type		R410A	R410A
Sound Pressure⁶			
Indoor (H/M/L)	dB(A)	37 / 35 / 34	44 / 42 / 40
Outdoor Max (Cool / Heat)	dB(A)	48 / 52	52 / 54
Piping⁷			
Liquid Pipe	in	3/8	3/8
Vapor Pipe	in	5/8	5/8
Pipe Length (Min/Max)	ft	16.4 / 164.0	16.4 / 246.1
Max Pipe Elevation	ft	98.4	98.4
Precharge Pipe Length	ft	24.6	24.6
Additional Refrigerant	oz/ft	0.43	0.43
Drain (OD, ID)	in	1-1/4, 1	1-1/4, 1
Controller	Additional Accessory ⁸	Wired Controller	Wired Controller

Note:

¹ Rated capacity at 0 ft. above sea level with 25 ft. of refrigerant line and a 0 ft. level difference between outdoor and indoor unit.

² Rated cooling capacity obtained with air entering the indoor unit at 80°F dry bulb (DB) and 67°F wet bulb (WB) and outdoor ambient conditions of 95°F dry bulb (DB) and 75°F wet bulb (WB). Rated heating capacity obtained with air entering the indoor unit at 70°F dry bulb (DB) and 60°F wet bulb (WB) and outdoor ambient conditions of 47°F dry bulb (DB) and 43°F wet bulb (WB). For capacity information, see engineering manual capacity tables.

³ All power/communication wiring minimum 4-conductor, stranded, shielded, and must comply with applicable local and national codes.

⁴ Installation of an optional Low Ambient Wind Baffle Kit will allow operation down to -4°F in cooling mode for applicable outdoor units.

⁵ Airflow shown is in heating and cooling mode.

⁶ Sound pressure levels are tested in an anechoic chamber under ISO Standard 3745 and are the same in both cooling and heating mode. These values can increase due to ambient conditions during operation.

⁷ Piping lengths are equivalent.

⁸ All LG wired controls are compatible and can be considered for control.

Due to our commitment to continued innovation, some specifications may be changed without notification.

HIGH STATIC DUCTED with LGRED°



LGRED°
LG ThinQ®

LH248HHV4

LH368HHV4
LH428HHV4
LH488HHV4



Specification	Unit	LH248HHV4	LH368HHV4	LH428HHV	LH488HHV
Indoor Unit		LHN248HV	LHN368HV	LHN428HV	LHN488HV
Outdoor Unit		LUU240HHV	LUU360HHV	LUU420HHV	LUU480HHV
Rated Cooling Capacity	Btu/h	23,000	36,000	42,000	46,000
Cooling Capacity Range	Btu/h	9,200 - 32,000	14,400 - 44,000	16,800 - 50,000	18,400 - 55,000
Rated Heating Capacity	Btu/h	27,000	40,000	48,000	50,000
Heating Capacity Range	Btu/h	8,000 - 36,000	16,000 - 46,000	18,000 - 57,600	19,000 - 60,000
Capacity^{1,2}					
Max Heating Capacity at 17°F	Btu/h	29,500	41,700	50,700	52,800
Max Heating Capacity at 5°F	Btu/h	28,400	33,600	39,500	41,000
Max Heating Capacity at -4°F	Btu/h	24,250	35,970	41,820	43,590
SEER2, EER2		16.75, 12.00	18.30, 12.00	18.70, 12.05	17.70, 11.70
HSPF2		9.40	9.20	9.15	9.40
Power					
Voltage (IDU)	V, Hz, Ø	208/230, 60, 1	208/230, 60, 1	208/230, 60, 1	208/230, 60, 1
Voltage (ODU)	V, Hz, Ø	208/230, 60, 1	208/230, 60, 1	208/230, 60, 1	208/230, 60, 1
Cooling Power Input	kW	1.92	3.00	3.49	3.93
Heating Power Input	kW	2.16	3.37	4.37	4.54
MCA, MOCP	A	22.0, 30.0	32.0, 40.0	32.0, 40.0	32.0, 40.0
Power/Communication Wiring ³	No. x AWG	4 x 14	4 x 14	4 x 14	4 x 14
Rated Amps Cool/Heat	A	17.70 / 17.70	27.50 / 27.50	26.50 / 26.50	26.50 / 26.50
Operating Range					
ODU Cooling Operation Range	°F WB	-13 - 64	-13 - 64	-13 - 64	-13 - 64
ODU Heating Operation Range	°F DB	5 - 118	5 - 118	5 - 118	5 - 118
Optional Wind Baffle ⁴		ZLABGP04A (-4°F)	ZLABGP04A x 2 (-4°F)	ZLABGP04A x 2 (-4°F)	ZLABGP04A x 2 (-4°F)
IDU Operation Range Cooling	°F WB	57 - 77	57 - 77	57 - 77	57 - 77
IDU Operation Range Heating	°F DB	59 - 81	59 - 81	59 - 81	59 - 81
Setpoint Range Cooling	°F	65 - 86	65 - 86	65 - 86	65 - 86
Setpoint Range Heating	°F	61 - 86	61 - 86	61 - 86	61 - 86
Dimensions					
IDU Dimensions (WxHxD)	in	35-7/16 x 10-5/8 x 27-9/16	49-7/32 x 10-5/8 x 27-9/16	49-7/32 x 14-3/16 x 27-9/16	49-7/32 x 14-3/16 x 27-9/16
ODU Dimensions (WxHxD)	in	37-13/32 x 32-27/32 x 13	37-13/32 x 54-11/32 x 13	37-13/32 x 54-11/32 x 13	37-13/32 x 54-11/32 x 13
Weight					
IDU Weight (Net/Shipping)	lbs	58.6 / 71.9	85.3 / 99.4	95.9 / 112.9	95.9 / 112.9
ODU Weight (Net/Shipping)	lbs	133.4 / 144.4	198.9 / 223.1	210.9 / 234.1	210.9 / 234.1
Airflow (H/M/L) ⁵	CFM	777 / 706 / 636	1,130 / 998 / 847	1,412 / 1,200 / 988	1,765 / 1,589 / 1,412
Unit Data					
Dehumidification	pts/hr	3.48	7.90	7.19	7.61
Max External Static Pressure	in wg	0.59	0.59	0.59	0.59
Compressor Type		R1 Scroll	R1 Scroll	R1 Scroll	R1 Scroll
Refrigerant Type		R410A	R410A	R410A	R410A
Sound Pressure⁶					
Indoor (H/M/L)	dB(A)	37 / 35 / 34	36 / 34 / 33	39 / 37 / 35	42 / 40 / 39
Outdoor Max (Cool / Heat)	dB(A)	51 / 52	52 / 54	54 / 56	54 / 56
Piping⁷					
Liquid Pipe	in	3/8	3/8	3/8	3/8
Vapor Pipe	in	5/8	5/8	5/8	5/8
Pipe Length (Min/Max)	ft	16.4 / 164.0	16.4 / 246.1	16.4 / 246.1	16.4 / 246.1
Max Pipe Elevation	ft	98.4	98.4	98.4	98.4
Precharge Pipe Length	ft	24.9	24.9	24.9	24.9
Additional Refrigerant	oz/ft	0.43	0.43	0.43	0.43
Drain (OD, ID)	in	1-1/4, 1	1-1/4, 1	1-1/4, 1	1-1/4, 1
Controller	Additional Accessory ⁸	Wired Controller	Wired Controller	Wired Controller	Wired Controller

Note:

¹ Rated capacity at 0 ft. above sea level with 25 ft. of refrigerant line and a 0 ft. level difference between outdoor and indoor unit.

² Rated cooling capacity obtained with air entering the indoor unit at 80°F dry bulb (DB) and 67°F wet bulb (WB) and outdoor ambient conditions of 95°F dry bulb (DB) and 75°F wet bulb (WB).

³ Rated heating capacity obtained with air entering the indoor unit at 70°F dry bulb (DB) and 60°F wet bulb (WB) and outdoor ambient conditions of 47°F dry bulb (DB) and 43°F wet bulb (WB).

For capacity information, see engineering manual capacity tables.

⁴ All power/communication wiring minimum 4-conductor, stranded, shielded, and must comply with applicable local and national codes.

⁵ Installation of an optional Low Ambient Wind Baffle Kit will allow operation down to -4°F in cooling mode for applicable outdoor units.

⁶ Airflow shown is in heating and cooling mode.

⁷ Sound pressure levels are tested in an anechoic chamber under ISO Standard 3745 and are the same in both cooling and heating mode. These values can increase due to ambient conditions during operation.

⁸ Piping lengths are equivalent.

⁹ All LG wired controls are compatible and can be considered for control.

Due to our commitment to continued innovation, some specifications may be changed without notification.

MULTI-POSITION AIR HANDLER UNIT



LG ThinQ®

LV181HV
LV241HV

LV361HV
LV420HV1
LV480HV1



Specification	Unit	LV181HV	LV241HV	LV300HV	LV361HV
Indoor Unit		LVN181HV4	LVN241HV4	LVN300HCV	LVN361HV4
Outdoor Unit		LUU180HV	LUU240HV	LUU360HV	LUU360HV
Rated Cooling Capacity	Btu/h	18,000	24,000	30,000	36,000
Cooling Capacity Range	Btu/h	7,200 - 24,000	9,600 - 30,000	12,000 - 32,500	14,400 - 39,000
Rated Heating Capacity	Btu/h	20,000	27,000	34,000	40,000
Heating Capacity Range	Btu/h	8,000 - 24,000	10,800 - 30,000	13,600 - 36,600	16,000 - 43,000
Capacity ^{1,2}					
Max Heating Capacity at 17°F	Btu/h	21,000	26,000	34,810	37,350
Max Heating Capacity at 5°F	Btu/h	16,200	21,400	32,600	33,800
Max Heating Capacity at -4°F	Btu/h	19,910	20,760	31,080	32,220
SEER2, EER2		17.25, 12.30	17.60, 11.45	17.00, 12.80	16.25, 11.00
HSPF2		9.25	9.70	9.20	8.95
Power					
Voltage (IDU)	V, Hz, Ø	208/230, 60, 1	208/230, 60, 1	208/230, 60, 1	208/230, 60, 1
Voltage (ODU)	V, Hz, Ø	208/230, 60, 1	208/230, 60, 1	208/230, 60, 1	208/230, 60, 1
Cooling Power Input	kW	1.46	2.10	2.34	3.27
Heating Power Input	kW	1.73	2.31	2.85	3.65
MCA, MOCP	A	20.0, 30.0	20.0, 30.0	32.0, 40.0	32.0, 40.0
Power/Communication Wiring ³	No. x AWG	4 x 14	4 x 14	4 x 14	4 x 14
Rated Amps Cool	A	16.20	16.20	26.30	26.30
Operating Range					
ODU Heating Operation Range	°F WB	-4 - 64	-4 - 64	-4 - 64	-4 - 64
ODU Cooling Operation Range	°F DB	5 - 118	5 - 118	5 - 118	5 - 118
Optional Wind Baffle ⁴		ZLABGP04A (-4°F)	ZLABGP04A (-4°F)	ZLABGP04A x 2 (-4°F)	ZLABGP04A x 2 (-4°F)
IDU Operation Range Cooling	°F WB	57 - 77	57 - 77	57 - 77	57 - 77
IDU Operation Range Heating	°F DB	59 - 81	59 - 81	59 - 81	59 - 81
Setpoint Range Cooling	°F	65 - 86	65 - 86	65 - 86	65 - 86
Setpoint Range Heating	°F	61 - 86	61 - 86	61 - 86	61 - 86
Dimensions					
IDU Dimensions (WxHxD)	in	18 x 48-21/32 x 21-13/32	18 x 48-21/32 x 21-13/32	18 x 48-21/32 x 21-13/32	18 x 48-21/32 x 21-13/32
ODU Dimensions (WxHxD)	in	37-13/32 x 32-27/32 x 13	37-13/32 x 32-27/32 x 13	37-13/32 x 54-11/32 x 13	37-13/32 x 54-11/32 x 13
Weight					
IDU Weight (Net/Shipping)	lbs	116.8 / 128.5	116.8 / 128.5	122.4 / 134.0	122.3 / 134.0
ODU Weight (Net/Shipping)	lbs	130.1 / 147.7	130.1 / 147.7	193.1 / 217.4	193.1 / 217.4
Unit Data					
Airflow (H/M/L) ⁵	CFM	640 / 580 / 480	710 / 640 / 480	960 / 880 / 800	990 / 880 / 800
Dehumidification	pts/hr	4.20	4.00	5.10	5.10
Max External Static Pressure	in wg	0.70	0.70	0.70	0.70
Fan Motor Type		Constant CFM ECM	Constant CFM ECM	Constant CFM ECM	Constant CFM ECM
Compressor Type		Twin Rotary	Twin Rotary	R1 Scroll	R1 Scroll
Refrigerant Type		R410A	R410A	R410A	R410A
Sound Pressure ⁶					
Indoor (H/M/L)	dB(A)	35 / 33 / 30	36 / 34 / 30	44 / 41 / 39	44 / 41 / 39
Outdoor Max (Cool / Heat)	dB(A)	48 / 52	48 / 52	52 / 54	52 / 54
Piping ⁷					
Liquid Pipe	in	3/8	3/8	3/8	3/8
Vapor Pipe	in	5/8	5/8	5/8	5/8
Pipe Length (Min/Max)	ft	16.4 / 164.0	16.4 / 164.0	16.4 / 246.0	16.4 / 246.0
Max Pipe Elevation	ft	98.4	98.4	98.4	98.4
Precharge Pipe Length	ft	24.6	24.6	24.6	24.6
Additional Refrigerant	oz/ft	0.43	0.43	0.43	0.43
Drain (OD, ID)	in	Primary & Secondary: 3/4 FPT	Primary & Secondary: 3/4 FPT	Primary & Secondary: 3/4 FPT	Primary & Secondary: 3/4 FPT
Controller	Additional Accessory ⁸	Wired Controller	Wired Controller	Wired Controller	Wired Controller

Note:

¹ Rated capacity at 0 ft. above sea level with 25 ft. of refrigerant line and a 0 ft. level difference between outdoor and indoor unit.

² Rated cooling capacity obtained with air entering the indoor unit at 80°F dry bulb (DB) and 67°F wet bulb (WB) and outdoor ambient conditions of 95°F dry bulb (DB) and 75°F wet bulb (WB).

³ Rated heating capacity obtained with air entering the indoor unit at 70°F dry bulb (DB) and 60°F wet bulb (WB) and outdoor ambient conditions of 47°F dry bulb (DB) and 43°F wet bulb (WB). For capacity information, see engineering manual capacity tables.

⁴ All power/communication wiring minimum 4-conductor, stranded, shielded, and must comply with applicable local and national codes.

⁵ Installation of an optional Low Ambient Wind Baffle Kit will allow operation down to -4°F in cooling mode for applicable outdoor units.

⁶ Airflow shown is in heating and cooling mode.

⁷ Sound pressure levels are tested in an anechoic chamber under ISO Standard 3745 and are the same in both cooling and heating mode. These values can increase due to ambient conditions during operation.

⁸ Piping lengths are equivalent.

⁹ All LG wired controls are compatible and can be considered for control.

Due to our commitment to continued innovation, some specifications may be changed without notification.

MULTI-POSITION AIR HANDLER UNIT



LG ThinQ®

LV181HV
LV241HV

LV361HV
LV420HV1
LV480HV1



SINGLE-ZONE

DUCTED

Specification	Unit	LV420HV1	LV420HV2	LV480HV1	LV480HV2	LV600HV	
Indoor Unit		LVN420HV	LVN420HV	LVN480HV	LVN480HV	LVN600HV	
Outdoor Unit		LUU420HV	LUU601HV	LUU480HV	LUU601HV	LUU601HV	
Rated Cooling Capacity	Btu/h	42,000	42,000	48,000	46,000	52,500	
Cooling Capacity Range	Btu/h	17,000 ~ 48,000	17,000 ~ 48,000	18,000 ~ 53,000	18,000 ~ 53,000	20,500 ~ 60,500	
Rated Heating Capacity	Btu/h	47,000	48,000	50,000	50,000	56,500	
Heating Capacity Range	Btu/h	18,000 ~ 55,000	18,000 ~ 51,800	19,000 ~ 60,000	19,000 ~ 54,000	21,500 ~ 61,000	
Capacity ^{1,2}	Max Heating Capacity at 17°F	39,000	38,800	40,000	39,580	41,640	
	Max Heating Capacity at 5°F	38,500	40,000	39,500	40,500	41,500	
	Max Heating Capacity at -4°F	32,890	33,440	33,020	33,860	34,690	
	SEER2, EER2	17.20, 10.75	17.20, 11.70	16.50, 9.70	17.50, 11.70	16.50, 11.70	
HSPF2		9.35	9.30	9.30	9.20	9.20	
Power	Voltage (IDU)	V, Hz, Ø	208/230, 60, 1	208/230, 60, 1	208/230, 60, 1	208/230, 60, 1	208/230, 60, 1
	Voltage (ODU)	V, Hz, Ø	208/230, 60, 1	208/230, 60, 1	208/230, 60, 1	208/230, 60, 1	208/230, 60, 1
	Cooling Power Input	kW	3.91	3.59	4.95	3.93	4.49
	Heating Power Input	kW	3.95	3.69	4.19	3.85	4.73
MCA, MOCP	A	32.0, 40.0	32.0, 40.0	32.0, 40.0	32.0, 40.0	32.0, 40.0	
Power/Communication Wiring ³	No. x AWG	4 x 14	4 x 14	4 x 14	4 x 14	4 x 14	
Rated Amps Cool	A	27.40	27.40	27.40	27.40	27.40	
Operating Range	ODU Heating Operation Range	°F WB	-4 ~ 64	-4 ~ 64	-4 ~ 64	-4 ~ 64	-4 ~ 64
	ODU Cooling Operation Range	°F DB	5 ~ 118	5 ~ 118	5 ~ 118	5 ~ 118	5 ~ 118
	Optional Wind Baffle ⁴		ZLABGP04A x 2 (-4°F)	ZLABGP04A x 2 (-4°F)	ZLABGP04A x 2 (-4°F)	ZLABGP04A x 2 (-4°F)	ZLABGP04A x 2 (-4°F)
	IDU Operation Range Cooling	°F WB	57 ~ 77	57 ~ 77	57 ~ 77	57 ~ 77	57 ~ 77
	IDU Operation Range Heating	°F DB	59 ~ 81	59 ~ 81	59 ~ 81	59 ~ 81	59 ~ 81
	Setpoint Range Cooling	°F	65 ~ 86	65 ~ 86	65 ~ 86	65 ~ 86	65 ~ 86
Dimensions	IDU Dimensions (WxHxD)	in	25 x 55-3/16 x 21-1/4	25 x 55-3/16 x 21-1/4	25 x 55-3/16 x 21-1/4	25 x 55-3/16 x 21-1/4	25 x 55-3/16 x 21-1/4
	ODU Dimensions (WxHxD)	in	37-13/32 x 54-11/32 x 13	37-13/32 x 54-11/32 x 13	37-13/32 x 54-11/32 x 13	37-13/32 x 54-11/32 x 13	37-13/32 x 54-11/32 x 13
Weight	IDU Weight (Net/Shipping)	lbs	158.7 / 176.4	158.7 / 176.4	158.7 / 176.4	158.7 / 176.4	158.7 / 176.4
	ODU Weight (Net/Shipping)	lbs	193.1 / 217.4	210.8 / 234.6	193.1 / 217.4	210.8 / 234.6	210.8 / 234.6
Unit Data	Airflow (H/M/L) ⁵	CFM	1,260 / 1,100 / 1,000	1,260 / 1,100 / 1,000	1,400 / 1,260 / 1,000	1,400 / 1,260 / 1,000	1,475 / 1,400 / 1,260
	Dehumidification	pts/hr	9.10	9.10	11.00	11.00	12.0
	Max External Static Pressure	in wg	1.00	1.00	1.00	1.00	1.00
	Fan Motor Type		BLDC	BLDC	BLDC	BLDC	BLDC
	Compressor Type		R1 Scroll	R1 Scroll	R1 Scroll	R1 Scroll	R1 Scroll
Sound Pressure ⁶	Refrigerant Type		R410A	R410A	R410A	R410A	R410A
	Indoor (H/M/L)	dB(A)	48 / 45 / 44	49 / 48 / 44	49 / 48 / 44	49 / 48 / 44	50 / 49 / 48
	Outdoor Max (Cool / Heat)	dB(A)	52 / 54	52 / 54	52 / 54	52 / 54	52 / 54
	Liquid Pipe	in	3/8	3/8	3/8	3/8	3/8
Piping ⁷	Vapor Pipe	in	5/8	5/8	5/8	5/8	5/8
	Pipe Length (Min/Max)	ft	16.4 / 246.0	16.4 / 246.0	16.4 / 246.0	16.4 / 246.0	16.4 / 246.0
	Max Pipe Elevation	ft	98.4	98.4	98.4	98.4	98.4
	Precharge Pipe Length	ft	24.6	24.6	24.6	24.6	24.6
	Additional Refrigerant	oz/ft	0.43	0.43	0.43	0.43	0.43
Drain (OD, ID)	in	Primary & Secondary: 3/4 FPT	Primary & Secondary: 3/4 FPT	Primary & Secondary: 3/4 FPT	Primary & Secondary: 3/4 FPT	Primary & Secondary: 3/4 FPT	
Controller	Additional Accessory ⁸	Wired Controller	Wired Controller	Wired Controller	Wired Controller	Wired Controller	

Note:

¹ Rated capacity at 0 ft. above sea level with 25 ft. of refrigerant line and a 0 ft. level difference between outdoor and indoor unit.

² Rated cooling capacity obtained with air entering the indoor unit at 80°F dry bulb (DB) and 67°F wet bulb (WB) and outdoor ambient conditions of 95°F dry bulb (DB) and 75°F wet bulb (WB). Rated heating capacity obtained with air entering the indoor unit at 70°F dry bulb (DB) and 60°F wet bulb (WB) and outdoor ambient conditions of 47°F dry bulb (DB) and 43°F wet bulb (WB). For capacity information, see engineering manual capacity tables.

³ All power/communication wiring minimum 4-conductor, stranded, shielded, and must comply with applicable local and national codes.

⁴ Installation of an optional Low Ambient Wind Baffle Kit will allow operation down to -4°F in cooling mode for applicable outdoor units.

⁵ Airflow shown is in heating and cooling mode.

⁶ Sound pressure levels are tested in an anechoic chamber under ISO Standard 3745 and are the same in both cooling and heating mode. These values can increase due to ambient conditions during operation.

⁷ Piping lengths are equivalent.

⁸ All LG wired controls are compatible and can be considered for control.

Due to our commitment to continued innovation, some specifications may be changed without notification.

MULTI-POSITION AIR HANDLER UNIT with LGRED°



LGRED°
LG ThinQ®

LV181HHV4
LV241HHV4

LV361HHV4
LV420HHV
LV480HHV



Specification	Unit	LV181HHV4	LV241HHV4	LV361HHV4	LV420HHV	LV480HHV
Indoor Unit		LVN181HV4	LVN241HV4	LVN361HV4	LVN420HV	LVN480HV
Outdoor Unit		LUU180HHV	LUU240HHV	LUU360HHV	LUU420HHV	LUU480HHV
Rated Cooling Capacity	Btu/h	18,000	24,000	33,000	42,000	46,000
Cooling Capacity Range	Btu/h	7,200 - 24,800	9,600 - 30,000	14,400 - 44,000	16,800 - 50,000	18,400 - 55,000
Rated Heating Capacity	Btu/h	20,000	27,000	37,500	48,000	50,000
Heating Capacity Range	Btu/h	8,000 - 27,000	10,800 - 36,000	16,000 - 43,000	18,000 - 60,000	19,000 - 63,000
Capacity ^{1,2}						
Max Heating Capacity at 17°F	Btu/h	23,400	29,500	39,000	51,400	53,700
Max Heating Capacity at 5°F	Btu/h	16,500	24,200	33,800	40,000	40,500
Max Heating Capacity at -4°F	Btu/h	20,840	24,250	33,810	38,200	39,960
SEER2, EER2		17.05, 13.35	16.45, 11.90	16.40, 11.95	17.30, 12.00	17.75, 11.95
HSPF2		8.90	9.25	9.30	9.45	9.40
Power						
Voltage (IDU)	V, Hz, Ø	208/230, 60, 1	208/230, 60, 1	208/230, 60, 1	208/230, 60, 1	208/230, 60, 1
Voltage (ODU)	V, Hz, Ø	208/230, 60, 1	208/230, 60, 1	208/230, 60, 1	208/230, 60, 1	208/230, 60, 1
Cooling Power Input	kW	1.35	2.02	2.76	3.50	3.85
Heating Power Input	kW	1.75	2.35	3.40	3.68	3.83
MCA, MOCP	A	22.0, 30.0	22.0, 30.0	32.0, 40.0	32.0, 40.0	32.0, 40.0
Power/Communication Wiring ³	No. x AWG	4 x 14	4 x 14	4 x 14	4 x 14	4 x 14
Rated Amps Cool	A	16.70	16.70	26.30	27.40	26.70
Operating Range						
ODU Heating Operation Range	°F WB	-13 - 64	-13 - 64	-13 - 64	-13 - 64	-13 - 64
ODU Cooling Operation Range	°F DB	5 / 118	5 - 118	5 - 118	5 - 118	5 - 118
Optional Wind Baffle ⁴		ZLABGP04A (-4°F)	ZLABGP04A (-4°F)	ZLABGP04A x 2 (-4°F)	ZLABGP04A x 2 (-4°F)	ZLABGP04A x 2 (-4°F)
IDU Operation Range Cooling	°F WB	57 - 77	57 - 77	57 - 77	57 - 77	57 - 77
IDU Operation Range Heating	°F DB	59 - 81	59 - 81	59 - 81	59 - 81	59 - 81
Setpoint Range Cooling	°F	65 - 86	65 - 86	65 - 86	65 - 86	65 - 86
Setpoint Range Heating	°F	61 - 86	61 - 86	61 - 86	61 - 86	61 - 86
Dimensions						
IDU Dimensions (WxHxD)	in	18 x 48-11/16 x 21-1/4	18 x 48-11/16 x 21-1/4	18 x 48-11/16 x 21-1/4	25 x 55-3/16 x 21-1/4	25 x 55-3/16 x 21-1/4
ODU Dimensions (WxHxD)	in	37-13/32 x 32-27/32 x 13	37-13/32 x 32-27/32 x 13	37-13/32 x 54-11/32 x 13	37-13/32 x 54-11/32 x 13	37-13/32 x 54-11/32 x 13
Weight						
IDU Weight (Net/Shipping)	lbs	116.8 / 128.5	116.8 / 128.5	122.4 / 134.0	158.7 / 176.4	158.7 / 176.4
ODU Weight (Net/Shipping)	lbs	133.4 / 144.4	133.4 / 144.4	198.9 / 223.1	210.9 / 234.1	210.9 / 234.1
Unit Data						
Airflow (H/M/L) ⁵	CFM	640 / 580 / 480	710 / 640 / 480	988 / 883 / 798	1,260 / 1,100 / 1,000	1,400 / 1,260 / 1,000
Dehumidification	pts/hr	3.14	4.18	7.40	6.76	7.54
Max External Static Pressure	in wg	0.70	0.70	0.70	1.00	1.00
Fan Motor Type		(ECM) / Direct	(ECM) / Direct	(ECM) / Direct	BLDC / Direct	BLDC / Direct
Compressor Type		Twin Rotary	Twin Rotary	R1 Scroll	Twin Rotary	Twin Rotary
Refrigerant Type		R410A	R410A	R410A	R410A	R410A
Sound Pressure ⁶						
Indoor (H/M/L)	dB(A)	35 / 33 / 30	36 / 34 / 30	44 / 41 / 39	48 / 45 / 44	49 / 48 / 44
Outdoor Max (Cool / Heat)	dB(A)	51 / 52	51 / 52	52 / 54	54 / 56	54 / 56
Piping ⁷						
Liquid Pipe	in	3/8	3/8	3/8	3/8	3/8
Vapor Pipe	in	5/8	5/8	5/8	5/8	5/8
Pipe Length (Min/Max)	ft	16.4 / 164.0	16.4 / 164.0	16.4 / 246.0	16.4 / 246.0	16.4 / 246.0
Max Pipe Elevation	ft	98.4	98.4	98.4	98.4	98.4
Precharge Pipe Length	ft	24.9	24.9	24.9	24.9	24.9
Additional Refrigerant	oz/ft	0.43	0.43	0.43	0.43	0.43
Drain (OD, ID)	in	Primary & Secondary: 3/4 FPT	Primary & Secondary: 3/4 FPT	Primary & Secondary: 3/4 FPT	Primary & Secondary: 3/4 FPT	Primary & Secondary: 3/4 FPT
Controller	Additional Accessory ⁸	Wired Controller	Wired Controller	Wired Controller	Wired Controller	Wired Controller

Note:

¹ Rated capacity at 0 ft. above sea level with 25 ft. of refrigerant line and a 0 ft. level difference between outdoor and indoor unit.

² Rated cooling capacity obtained with air entering the indoor unit at 80 °F dry bulb (DB) and 67 °F wet bulb (WB) and outdoor ambient conditions of 95 °F dry bulb (DB) and 75 °F wet bulb (WB).

³ Rated heating capacity obtained with air entering the indoor unit at 70 °F dry bulb (DB) and 60 °F wet bulb (WB) and outdoor ambient conditions of 47 °F dry bulb (DB) and 43 °F wet bulb (WB). For capacity information, see engineering manual capacity tables.

⁴ All power/communication wiring minimum 4-conductor, stranded, shielded, and must comply with applicable local and national codes.

⁵ Installation of an optional Low Ambient Wind Baffle Kit will allow operation down to -4 °F in cooling mode for applicable outdoor units.

⁶ Airflow shown is in heating and cooling mode.

⁷ Sound pressure levels are tested in an anechoic chamber under ISO Standard 3745 and are the same in both cooling and heating mode. These values can increase due to ambient conditions during operation.

⁸ Piping lengths are equivalent.

⁹ All LG wired controls are compatible and can be considered for control.

Due to our commitment to continued innovation, some specifications may be changed without notification.

MULTI-POSITION AIR HANDLER UNIT - CV



LG ThinQ®

LV120HCV
LV180HCV
LV240HCV
LV300HCV



SINGLE-ZONE

DUCTED

Specification	Unit	LV120HCV	LV180HCV	LV240HCV	LV300HCV
Indoor Unit		LVN120HCV	LVN181HV4	LVN241HV4	LVN300HCV
Outdoor Unit		LVU120HCV	LVU180HCV	LVU240HCV	LVU300HCV
Rated Cooling Capacity	Btu/h	12,000	18,000	22,400	30,000
Cooling Capacity Range	Btu/h	4,200 - 15,000	6,300 - 21,000	7,840 - 26,000	10,500 - 33,000
Rated Heating Capacity	Btu/h	15,000	20,000	24,000	30,000
Heating Capacity Range	Btu/h	6,000 - 20,000	8,000 - 25,000	9,500 - 29,000	12,000 - 34,000
Capacity ^{1,2}					
Max Heating Capacity at 17°F	Btu/h	14,000	17,400	20,000	25,000
Max Heating Capacity at 5°F	Btu/h	13,000	15,000	17,000	22,000
Max Heating Capacity at -4°F	Btu/h	11,820	12,160	13,450	18,450
SEER2, EER2		16.00, 12.20	15.60, 11.00	15.10, 9.50	15.50, 9.50
HSPF2		9.30	8.70	8.50	9.10
Power					
Voltage (IDU)	V, Hz, Ø	208/230, 60, 1	208/230, 60, 1	208/230, 60, 1	208/230, 60, 1
Voltage (ODU)	V, Hz, Ø	208/230, 60, 1	208/230, 60, 1	208/230, 60, 1	208/230, 60, 1
Cooling Power Input	kW	0.98	1.64	2.36	3.16
Heating Power Input	kW	1.26	1.83	2.27	2.66
MCA, MOCP	A	13.8, 20.0	15.4, 25.0	16.6, 25.0	19.5, 30.0
Power/Communication Wiring ³	No. x AWG	4 x 14	4 x 14	4 x 14	4 x 14
Rated Amps Cool	A	12.40	13.70	14.60	17.00
Operating Range					
ODU Heating Operation Range	°F WB	-4 - 64	-4 - 64	-4 - 64	-4 - 64
ODU Cooling Operation Range	°F DB	5 - 118	5 - 118	5 - 118	5 - 118
Optional Wind Baffle ⁴		ZLABGP03A (-4°F)	ZLABGP03A (-4°F)	ZLABGP03A (-4°F)	ZLABGP04A (-4°F)
IDU Operation Range Cooling	°F WB	57 - 77	57 - 77	57 - 77	57 - 77
IDU Operation Range Heating	°F DB	59 - 81	59 - 81	59 - 81	59 - 81
Setpoint Range Cooling	°F	65 - 86	65 - 86	65 - 86	65 - 86
Setpoint Range Heating	°F	61 - 86	61 - 86	61 - 86	61 - 86
Dimensions					
IDU Dimensions (WxHxD)	in	18 x 48-11/16 x 21-1/4	18 x 48-11/16 x 21-1/4	18 x 48-11/16 x 21-1/4	25 x 48-11/16 x 21-1/4
ODU Dimensions (WxHxD)	in	34-1/4 x 25-19/32 x 13	34-1/4 x 25-19/32 x 13	34-1/4 x 25-19/32 x 13	37-13/32 x 32-27/32 x 13
Weight					
IDU Weight (Net/Shipping)	lbs	116.8 / 128.5	116.8 / 128.5	116.8 / 128.5	122.4 / 134.0
ODU Weight (Net/Shipping)	lbs	100.3 / 109.0	100.3 / 109.0	100.3 / 109.0	130.3 / 143.3
Unit Data					
Airflow (H/M/L) ⁵	CFM	580 / 480 / 380	640 / 580 / 480	710 / 640 / 480	960 / 880 / 800
Dehumidification	pts/hr	2.40	3.10	4.00	4.50
Max External Static Pressure	in wg	0.60	0.70	0.70	0.70
Fan Motor Type		ECM	ECM	ECM	ECM
Compressor Type		Twin Rotary x 1	Twin Rotary x 1	Twin Rotary x 1	Twin Rotary x 1
Refrigerant Type		R410A	R410A	R410A	R410A
Sound Pressure ⁶					
Indoor (H/M/L)	dB(A)	34 / 31 / 28	35 / 33 / 30	36 / 34 / 30	44 / 41 / 39
Outdoor Max (Cool / Heat)	dB(A)	49 / 51	51 / 53	52 / 54	53 / 55
Piping ⁷					
Liquid Pipe	in	1/4	3/8	3/8	3/8
Vapor Pipe	in	3/8	5/8	5/8	5/8
Pipe Length (Min/Max)	ft	16.4 / 98.4	16.4 / 164.0	16.4 / 164.0	16.4 / 164.0
Max Pipe Elevation	ft	98.4	98.4	98.4	98.4
Precharge Pipe Length	ft	24.6	24.6	24.6	24.6
Additional Refrigerant	oz/ft	0.21	0.43	0.43	0.43
Drain (OD, ID)	in	Primary & Secondary: 3/4 FPT	Primary & Secondary: 3/4 FPT	Primary & Secondary: 3/4 FPT	Primary & Secondary: 3/4 FPT
Controller	Additional Accessory ⁸	Wired Controller	Wired Controller	Wired Controller	Wired Controller

Note:

¹ Rated capacity at 0 ft. above sea level with 25 ft. of refrigerant line and a 0 ft. level difference between outdoor and indoor unit.

² Rated cooling capacity obtained with air entering the indoor unit at 80°F dry bulb (DB) and 67°F wet bulb (WB) and outdoor ambient conditions of 95°F dry bulb (DB) and 75°F wet bulb (WB).
Rated heating capacity obtained with air entering the indoor unit at 70°F dry bulb (DB) and 60°F wet bulb (WB) and outdoor ambient conditions of 47°F dry bulb (DB) and 43°F wet bulb (WB).
For capacity information, see engineering manual capacity tables.

³ All power/communication wiring minimum 4-conductor, stranded, shielded, and must comply with applicable local and national codes.

⁴ Installation of an optional Low Ambient Wind Baffle Kit will allow operation down to -4°F in cooling mode for applicable outdoor units.

⁵ Airflow shown is in heating and cooling mode.















⁶ Sound pressure levels are tested in an anechoic chamber under ISO Standard 3745 and are the same in both cooling and heating mode. These values can increase due to ambient conditions during operation.

⁷ Piping lengths are equivalent.































⁸ All LG wired controls are compatible and can be considered for control.

Due to our commitment to continued innovation, some specifications may be changed without notification.

MULTI-ZONE Lineup

OUTDOOR UNITS				
Btu/h	Multi F		Maximum Indoor Units	Combination Sample
18,000	 LMU183HV	LGRED°  LMU180HHV	2	
24,000	 LMU243HV	LGRED°  LMU240HHV	3	
30,000	 LMU303HV	LGRED°  LMU300HHV	4	
36,000	 LMU363HV		4	
Btu/h	Multi F MAX		Maximum Indoor Units	Combination Sample
36,000	 LMU361HHV		5	
42,000	 LMU421HHV		6	
48,000	 LMU483HV	 LMU480HHV	8	
54,000	 LMU543HV		8	
60,000	 LMU601HV		8	

MULTI-ZONE Lineup

INDOOR UNITS								
Btu/h	7,000	9,000	12,000	15,000	18,000	24,000	36,000	
Wall Mounted	ART COOL™ Gallery	 LMAN097HVP	 LMAN127HVP					
	ART COOL™ Mirror	 LAN090HSV5	 LAN120HSV5		 LAN181HSV5			
	High Efficiency	 LMN079HVT	 LSN090HSV5	 LSN120HSV5	 LMN159HVT	 LSN181HSV5	 LMN249HVT	
	Low Wall Console		 LQN090HV4	 LQN120HV4	 LMQN150HV			
Ceiling Cassette	4-Way  LMCN078HV	 LCN098HV4	 LCN128HV4		 LCN188HV4			
Ducted	Low Static		 LMDN097HV4	 LMDN127HV4		 LMDN187HV4		
	Convertible Mid Static		 LHN098HV1	 LHN128HV1		 LHN188HV1	 LHN248HV1	
	High Static					 LHN248HV	 LHN368HV	
	Multi-Position Air Handler Unit					 LVN181HV4	 LVN241HV4	 LVN361HV4

MULTI F OUTDOOR UNITS

LMU183HV
LMU243HV



LMU303HV
LMU363HV



Specification	Unit	LMU183HV	LMU243HV	LMU303HV	LMU363HV	
Capacity ^{1,2}	Rated Cooling Capacity	Btu/h	18,000	24,000	30,000	32,800
	Cooling Capacity Range	Btu/h	8,400 - 21,600	8,400 - 25,000	8,400 - 36,000	8,400 - 38,400
	Rated Heating Capacity	Btu/h	22,000	24,600	32,000	36,000
	Heating Capacity Range	Btu/h	10,080 - 25,000	10,080 - 29,000	10,080 - 38,400	10,080 - 41,600
	Max Heating Capacity at 5 °F	Btu/h	17,700	18,400	24,000	25,200
	Max Heating Capacity at 0 °F	Btu/h	16,090	16,730	22,000	22,750
	Max Heating Capacity at -4 °F	Btu/h	14,800	15,400	20,400	20,800
	SEER2, EER2		22.50, 13.50	22.50, 12.50	22.00, 13.00	21.50, 12.50
	HSPF2		9.60	9.40	9.20	9.00
Power	Voltage	V, Hz, Ø	208/230, 60, 1	208/230, 60, 1	208/230, 60, 1	208/230, 60, 1
	Cooling Power Input	kW	1.33	1.92	2.31	2.62
	Heating Power Input	kW	1.79	1.72	2.34	2.74
	MCA, MOP	A	15.8, 20.0	16.0, 20.0	18.4, 25.0	18.4, 25.0
	Rated Amps (Cool/Heat)	A	12.80 / 12.80	13.00 / 13.00	15.03 / 15.03	15.03 / 15.03
	Power/Communication Wiring ³	No. x AWG	4 x 14	4 x 14	4 x 14	4 x 14
Operating Range ⁴	Heating Operation Range	°F WB	-4 - 64	-4 - 64	-4 - 64	-4 - 64
	Cooling Operation Range ⁵	°F DB	14 - 118	14 - 118	14 - 118	14 - 118
Dimensions & Weight	Optional Wind Baffle		ZLABGP03A (-4 °F)	ZLABGP03A (-4 °F)	ZLABGP04A (-4 °F)	ZLABGP04A (-4 °F)
	Dimensions (WxHxD)	in	34-1/4 x 25-19/32 x 13	34-1/4 x 25-19/32 x 13	37-13/32 x 32-27/32 x 13	37-13/32 x 32-27/32 x 13
Unit Data	Weight (Net/Shipping)	lbs	101.0 / 109.8	101.4 / 110.2	138.9 / 154.3	138.9 / 154.3
	Refrigerant Type		R410A	R410A	R410A	R410A
	Compressor Type		Twin Rotary	Twin Rotary	Twin Rotary	Twin Rotary
	Sound Pressure (Cooling / Heating) ⁶	dB(A)	49 / 54	50 / 54	51 / 54	51 / 54
	Maximum Air Volume	CFM	1,766	1,766	2,119	2,119
	Minimum Connectable IDUs ⁷	Qty	2	2	2	2
	Maximum Connectable IDUs ⁷	Qty	2	3	4	4
	Max Total IDU Connected Capacity	Btu/h	24,000	33,000	40,000	48,000
	Liquid Pipe (OD)	in	1/4 x 2	1/4 x 3	1/4 x 4	1/4 x 4
	Vapor Pipe (OD)	in	3/8 x 2	3/8 x 3	3/8 x 4	3/8 x 4
Piping ⁸	Maximum Total Pipe Length	ft	164.0	230.0	246.1	246.1
	Minimum Pipe Length per Segment	ft	9.8	9.8	9.8	9.8
	Maximum Pipe Length ODU to IDU	ft	82.0	82.0	82.0	82.0
	Piping Length (no add'l refrigerant)	ft	98.4	98.4	98.4	98.4
	Maximum Elevation ODU to IDU	ft	49.2	49.2	49.2	49.2
	Maximum Elevation IDU to IDU	ft	24.6	24.6	24.6	24.6
	Factory Charge of R410A	lbs	3.97	3.97	6.17	6.17

Note:

At least two operable indoor units must be connected to the outdoor unit.

Refer to the product engineering manual for instructions on how to calculate and properly apply the connected total indoor unit nominal capacity.

Rated cooling capacity obtained with air entering the indoor unit at 80 °F dry bulb (DB) and 67 °F wet bulb (WB) and outdoor ambient conditions of 95 °F dry bulb (DB) and 75 °F wet bulb (WB).

Rated heating capacity obtained with air entering the indoor unit at 70 °F dry bulb (DB) and 60 °F wet bulb (WB) and outdoor ambient conditions of 47 °F dry bulb (DB) and 43 °F wet bulb (WB).

For capacity information, see engineering manual capacity tables. Capacities are based on connection of Non-Ducted indoor units.

¹ Capacity is rated with non-ducted indoor units, 0 ft. above sea level, with a 0 ft. level difference between outdoor and indoor units, and the following refrigerant pipe lengths:

LMU183HV: 16.4 ft. x 2 = 32.8 ft., LMU243HV: 16.4 ft. x 3 = 49.2 ft., LMU303HV: 16.4 ft. x 4 = 65.6 ft., LMU363HV: 16.4 ft. x 4 = 65.6 ft.

² Rated capacity is certified under AHRI Standard 210 / 240. EER2, SEER2, COP, and HSPF2 are subject to change. See www.ahrinet.org for the latest values.

³ Power wiring to the outdoor unit is field supplied, solid or stranded, and must comply with the applicable local and national codes. All power wiring / communication cable to be minimum 14 AWG, 4-conductor from the outdoor unit to the indoor units, stranded, shielded or unshielded (if shielded, it must be grounded to the chassis of the outdoor unit only), and must comply with applicable local and national codes.

⁴ Operation outside of Continuous Operating Range is subject to safety interruption.

⁵ Cooling operation range with Low Ambient Wind Baffle Kit (sold separately) is -4°F to +118°F.

⁶ Sound pressure levels are tested in an anechoic chamber under ISO Standard 3745 and are the same in both cooling and heating mode. These values can increase due to ambient conditions during operation.

⁷ At least two indoor units must be connected. For allocated capacity information, see the combination tables in the "Multi F / Multi F MAX Combination Data Manual" on www.lghvac.com. For performance data, see "Multi F / Multi F MAX Performance Data Manual" on www.lghvac.com.

⁸ Piping lengths are equivalent.

Due to our commitment to continued innovation, some specifications may be changed without notification.

MULTI F OUTDOOR UNITS with LGRED°

LMU180HHV
LMU240HHV



LGRED°

LMU300HHV



LGRED°

MULTI-ZONE

OUTDOOR UNITS

Model	Specification	Unit	LMU180HHV	LMU240HHV	LMU300HHV
Capacity ^{1,2}	Rated Cooling Capacity	Btu/h	18,000	24,000	28,400
	Cooling Capacity Range	Btu/h	8,400 - 19,980	8,400 - 30,000	8,400 - 34,080
	Rated Heating Capacity	Btu/h	22,000	26,000	28,600
	Heating Capacity Range	Btu/h	10,248 - 24,000	10,248 - 31,200	10,248 - 34,320
	Max Heating Capacity at 17°F	Btu/h	23,600	28,500	31,600
	Max Heating Capacity at 5°F	Btu/h	22,000	26,000	28,600
	Max Heating Capacity at -4°F	Btu/h	21,050	23,880	25,550
	Max Heating Capacity at -13°F	Btu/h	19,270	21,310	22,210
SEER2, EER2 ³			21.00, 13.50	21.00, 13.50	20.00, 12.50
HSPF2 ³			9.20	9.80	9.80
Power	Voltage	V, Hz, Ø	208/230, 60, 1	208/230, 60, 1	208/230, 60, 1
	Cooling Power Input	kW	1.33	1.78	2.27
	Heating Power Input	kW	2.22	2.12	2.33
	MCA, MOCP ⁴	A	18.6, 30.0	19.0, 30.0	19.4, 30.0
	Rated Amps	A	15.33	15.73	16.13
	Power/Communication Wiring ⁵	No. x AWG	4 x 14	4 x 14	4 x 14
Operating Range	Heating Operation Range	°F WB	-13 - 64	-13 - 64	-13 - 64
	Cooling Operation Range	°F DB	14 - 118	14 - 118	14 - 118
	Optional Wind Baffle ⁶		ZLABGP04A (-4°F)	ZLABGP04A (-4°F)	ZLABGP04A (-4°F)
Dimensions & Weight	Dimensions (WxHxD)	in	37-13/32 x 32-27/32 x 13	37-13/32 x 32-27/32 x 13	37-13/32 x 32-27/32 x 13
	Weight (Net/Shipping)	lbs	147.7 / 163.1	152.1 / 165.3	152.1 / 165.3
Unit Data	Refrigerant Type		R410A	R410A	R410A
	Compressor Type		Twin Rotary	Twin Rotary	Twin Rotary
	Sound Pressure (Cooling / Heating) ⁷	dB(A)	51 / 54	52 / 55	52 / 55
	Maximum Air Volume	CFM	2,295	2,295	2,295
	Minimum Connectable IDUs	Qty	2	2	2
	Maximum Connectable IDUs	Qty	2	3	4
	Max Total IDU Connected Capacity	Btu/h	24,000	33,000	40,000
	Piping ⁸	Liquid Pipe	in	1/4 x 2	1/4 x 3
Vapor Pipe		in	3/8 x 2	3/8 x 3	3/8 x 4
Maximum Total Pipe Length		ft	164.0	246.1	246.1
Minimum Pipe Length per Segment		ft	9.8	9.8	9.8
Maximum Pipe Length ODU TO IDU		ft	82.0	82.0	82.0
Precharge Pipe Length		ft	49.2	73.8	98.4
Maximum Elevation ODU to IDU		ft	49.2	49.2	49.2
Maximum Elevation IDU to IDU		ft	24.6	24.6	24.6
Factory Charge of R410A		lbs	6.18	7.05	7.05
Additional Refrigerant	oz/ft	0.22	0.22	0.22	

Note:

At least two operable indoor units must be connected to the outdoor unit.

Refer to the product engineering manual for instructions on how to calculate and properly apply the connected total indoor unit nominal capacity.

¹Rated capacity at 0 ft. above sea level with 25 ft. of refrigerant line and a 0 ft. level difference between outdoor and indoor unit.

²Rated cooling capacity obtained with air entering the indoor unit at 80°F dry bulb (DB) and 67°F wet bulb (WB) and outdoor ambient conditions of 95°F dry bulb (DB) and 75°F wet bulb (WB).
³Rated heating capacity obtained with air entering the indoor unit at 70°F dry bulb (DB) and 60°F wet bulb (WB) and outdoor ambient conditions of 47°F dry bulb (DB) and 43°F wet bulb (WB).
 For capacity information, see engineering manual capacity tables. Capacities are based on connection of Non-Ducted indoor units.

³Values when matched with non-ducted units only.

⁴Recommended fuse size is 25 Amps.

⁵All power/communication wiring minimum 4-conductor, stranded, shielded, and must comply with applicable local and national codes.

⁶Installation of an optional Low Ambient Wind Baffle Kit will allow operation down to -4°F in cooling mode for applicable outdoor units.

⁷Sound pressure levels are tested in an anechoic chamber under ISO Standard 3745 and are the same in both cooling and heating mode. These values can increase due to ambient conditions during operation.

⁸Piping lengths are equivalent.

Due to our commitment to continued innovation, some specifications may be changed without notification.

MULTI F MAX OUTDOOR UNITS

LMU483HV
LMU543HV
LMU601HV



Specification	Unit	LMU483HV	LMU543HV	LMU601HV	
Capacity^{1,2}	Rated Cooling Capacity	Btu/h	48,000	50,500	60,000
	Cooling Capacity Range	Btu/h	10,800 - 58,000	10,800 - 63,200	10,800 - 65,000
	Rated Heating Capacity	Btu/h	54,000	58,000	64,000
	Heating Capacity Range	Btu/h	12,420 - 59,000	12,420 - 64,000	12,420 - 68,000
	Max Heating Capacity at 17 °F	Btu/h	46,500	48,000	56,500
	Max Heating Capacity at 5 °F	Btu/h	39,600	40,500	52,500
	Max Heating Capacity at -4 °F	Btu/h	34,500	35,200	45,200
	SEER2, EER2 ³		20.80, 12.80	20.60, 12.60	20.50, 11.30
Power	HSPF2 ³		9.50	9.30	10.00
	Voltage	V, Hz, Ø	208/230, 60, 1	208/230, 60, 1	208/230, 60, 1
	Cooling Power Input	kW	3.75	4.01	5.31
	Heating Power Input	kW	4.52	5.07	5.44
	MCA, MOCP	A	32.7, 40.0	32.7, 40.0	32.7, 40.0
	Rated Amps (Cool/Heat)	A	29.20	30.00	30.40
	Power/Communication Wiring ⁴	No. x AWG	ODU --> BDU: 4 x 14, BDU --> IDU: 4 x 14	ODU --> BDU: 4 x 14, BDU --> IDU: 4 x 14	ODU --> BDU: 4 x 14, BDU --> IDU: 4 x 14
	Heating Operation Range	°F WB	-4 - 64	-4 - 64	-4 - 64
Operating Range	Cooling Operation Range	°F DB	14 - 118	14 - 118	14 - 118
	Optional Wind Baffle ⁵		ZLABGP04A x 2 (-4 °F)	ZLABGP04A x 2 (-4 °F)	ZLABGP04A x 2 (-4 °F)
Dimensions & Weight	Dimensions (WxHxD)	in	37-13/32 x 54-11/32 x 13	37-13/32 x 54-11/32 x 13	37-13/32x54-11/32x13
	Weight (Net/Shipping)	lbs	194.0 / 218.0	194.0 / 218.0	218.3 / 242.5
Unit Data	Refrigerant Type		R410A	R410A	R-410A
	Compressor Type		R1 Scroll	R1 Scroll	R1 Scroll
	Sound Pressure (Cooling / Heating) ⁶	dB(A)	53 / 55	53 / 55	56 / 58
	Maximum Air Volume	CFM	1,942 x 2	1,942 x 2	2,119 x 2
	Minimum Connectable IDUs	Qty	2	2	2
	Maximum Connectable IDUs	Qty	8	8	8
	Max Total IDU Connected Capacity	Btu/h	65,000	73,000	81,000
Piping⁷	Liquid Pipe	in	3/8	3/8	3/8
	Vapor Pipe	in	3/4	3/4	3/4
	Maximum Total Pipe Length	ft	475.7	475.7	475.7
	Minimum Pipe Length per Segment	ft	16.4	16.4	16.4
	Maximum Pipe Length ODU to IDU	ft	229.6	229.6	229.6
	Maximum Main Pipe Length (ODU to BDU)	ft	180.4	180.4	180.4
	Precharge Pipe Length	ft	Main: 16.4, Branch: 131.2	Main: 16.4, Branch: 131.2	Main: 49.2, Branch: 131.2
	Maximum Elevation ODU to IDU	ft	98.4	98.4	98.4
	Maximum Elevation IDU to IDU	ft	49.2	49.2	49.2
	Maximum Elevation BDU to IDU	ft	32.8	32.8	38.2
	Maximum Elevation BDU to BDU	ft	49.2	49.2	49.2
	Factory Charge of R410A	lbs	9.3	9.3	11.5
	Additional Refrigerant	oz/ft	Main: 0.54, Branch: 0.22	Main: 0.54, Branch: 0.22	Main: 0.54, Branch: 0.22

Note:

At least two operable indoor units must be connected to the outdoor unit.

Refer to the product engineering manual for instructions on how to calculate and properly apply the connected total indoor unit nominal capacity.

¹ Rated capacity at 0 ft. above sea level with 25 ft. of refrigerant line and a 0 ft. level difference between outdoor and indoor unit.

² Rated cooling capacity obtained with air entering the indoor unit at 80 °F dry bulb (DB) and 67 °F wet bulb (WB) and outdoor ambient conditions of 95 °F dry bulb (DB) and 75 °F wet bulb (WB).

Rated heating capacity obtained with air entering the indoor unit at 70 °F dry bulb (DB) and 60 °F wet bulb (WB) and outdoor ambient conditions of 47 °F dry bulb (DB) and 43 °F wet bulb (WB).

For capacity information, see engineering manual capacity tables. Capacities are based on connection of Non-Ducted indoor units.

³ Values when matched with non-ducted units only.

⁴ All power/communication wiring minimum 4-conductor, stranded, shielded, and must comply with applicable local and national codes.

⁵ Installation of an optional Low Ambient Wind Baffle Kit will allow operation down to -4 °F in cooling mode for applicable outdoor units.

⁶ Sound pressure levels are tested in an anechoic chamber under ISO Standard 3745 and are the same in both cooling and heating mode. These values can increase due to ambient conditions during operation.

⁷ Piping lengths are equivalent.

Due to our commitment to continued innovation, some specifications may be changed without notification.

MULTI F MAX OUTDOOR UNITS with LGRED°



LMU361HHV
LMU421HHV
LMU480HHV

LGRED°

MULTI-ZONE

OUTDOOR UNITS

Specification	Unit	LMU361HHV	LMU421HHV	LMU480HHV	
Capacity ^{1,2}	Rated Cooling Capacity	Btu/h	36,000	42,000	48,000
	Cooling Capacity Range	Btu/h	10,800 - 47,000	10,800 - 53,000	10,800 - 58,000
	Rated Heating Capacity	Btu/h	45,000	48,000	52,500
	Heating Capacity Range	Btu/h	12,420 - 50,000	12,420 - 54,500	12,420 - 59,000
	Max Heating Capacity at 17°F	Btu/h	49,600	53,200	56,500
	Max Heating Capacity at 5°F	Btu/h	45,000	48,000	52,500
	Max Heating Capacity at -4°F	Btu/h	40,000	42,000	45,200
	Max Heating Capacity at -13°F	Btu/h	35,900	37,100	39,200
SEER2, EER2 ³		22.00, 14.50	21.50, 13.80	20.50, 13.10	
HSPF2 ³		11.00	11.00	10.50	
Power	Voltage	V, Hz, Ø	208/230, 60, 1	208/230, 60, 1	208/230, 60, 1
	Cooling Power Input	kW	2.48	3.04	3.66
	Heating Power Input	kW	3.30	3.70	4.25
	MCA, MOCP	A	32.7, 40.0	32.7, 40.0	32.7, 40.0
	Rated Amps	A	28.40	28.40	29.20
	Power/Communication Wiring ⁴	A	ODU --> BDU: 4 x 14, BDU --> IDU: 4 x 14	ODU --> BDU: 4 x 14, BDU --> IDU: 4 x 14	ODU --> BDU: 4 x 14, BDU --> IDU: 4 x 14
Operating Range	Heating Operation Range	°F WB	-13 - 64	-13 - 64	-13 - 64
	Cooling Operation Range	°F DB	14 - 118	14 - 118	14 - 118
	Optional Wind Baffle ⁵		ZLABGP04A x2 (-4°F)	ZLABGP04A x2 (-4°F)	ZLABGP04A x2 (-4°F)
Dimensions & Weight	Dimensions (WxHxD)	in	37-13/32 x 54-11/32 x 13	37-13/32 x 54-11/32 x 13	37-13/32 x 54-11/32 x 13
	Weight (Net/Shipping)	lbs	218.0 / 243.0	218.0 / 243.0	218.0 / 243.0
Unit Data	Refrigerant Type		R410A	R410A	R410A
	Compressor Type		R1 Scroll	R1 Scroll	R1 Scroll
	Sound Pressure (Cooling / Heating) ⁶	dB(A)	53 / 55	54 / 56	54 / 56
	Maximum Air Volume	CFM	2,119 x 2	2,119 x 2	2,119 x 2
	Minimum Connectable IDUs	Qty	2	2	2
	Maximum Connectable IDUs	Qty	5	6	8
	Max Total IDU Connected Capacity	Btu/h	48,000	56,000	65,000
	Piping ⁷	Liquid Pipe	in	3/8	3/8
Vapor Pipe		in	3/4	3/4	3/4
Maximum Total Pipe Length		ft	475.7	475.7	475.7
Minimum Pipe Length per Segment		ft	16.4	16.4	16.4
Maximum Pipe Length ODU to IDU		ft	229.6	229.6	229.6
Maximum Main Pipe Length (ODU to BDU)		ft	180.4	180.4	180.4
Maximum Branch Piping		ft	295.3	295.3	295.3
Maximum Pipe Length BDU to IDU		ft	49.2	49.2	49.2
Precharge Pipe Length		ft	Main: 49.2, Branch: 131.2	Main: 49.2, Branch: 131.2	Main: 49.2, Branch: 131.2
Maximum Elevation ODU to IDU		ft	98.4	98.4	98.4
Maximum Elevation IDU to IDU		ft	49.2	49.2	49.2
Maximum Elevation BDU to IDU		ft	32.8	32.8	32.8
Maximum Elevation BDU to BDU		ft	49.2	49.2	49.2
Factory Charge of R410A		lbs	11.5	11.5	11.5
Additional Refrigerant	oz/ft	Main: 0.54, Branch: 0.22	Main: 0.54, Branch: 0.22	Main: 0.54, Branch: 0.22	

Note:

At least two operable indoor units must be connected to the outdoor unit.

Refer to the product engineering manual for instructions on how to calculate and properly apply the connected total indoor unit nominal capacity.

¹ Rated capacity at 0 ft. above sea level with 25 ft. of refrigerant line and a 0 ft. level difference between outdoor and indoor unit.

² Rated cooling capacity obtained with air entering the indoor unit at 80°F dry bulb (DB) and 67°F wet bulb (WB) and outdoor ambient conditions of 95°F dry bulb (DB) and 75°F wet bulb (WB). Rated heating capacity obtained with air entering the indoor unit at 70°F dry bulb (DB) and 60°F wet bulb (WB) and outdoor ambient conditions of 47°F dry bulb (DB) and 43°F wet bulb (WB). For capacity information, see engineering manual capacity tables. Capacities are based on connection of Non-Ducted indoor units.

³ Values when matched with non-ducted units only.

⁴ All power/communication wiring minimum 4-conductor, stranded, shielded, and must comply with applicable local and national codes.

⁵ Installation of an optional Low Ambient Wind Baffle Kit will allow operation down to -4°F in cooling mode for applicable outdoor units.

⁶ Sound pressure levels are tested in an anechoic chamber under ISO Standard 3745 and are the same in both cooling and heating mode. These values can increase due to ambient conditions during operation.

⁷ Piping lengths are equivalent.

Due to our commitment to continued innovation, some specifications may be changed without notification.

MULTI F INDOOR UNITS

MULTI-ZONE

INDOOR UNITS

LG ThinQ®



ART COOL™ Gallery

Specification	Unit	LMAN097HVP	LMAN127HVP	
Capacity ^{1,2}	Cooling	Btu/h	9,000	11,200
	Heating	Btu/h	10,400	13,300
Power	Voltage	V, Hz, Ø	208/230, 60, 1	208/230, 60, 1
	Power/Communication Wiring ³	No. x AWG	4 x 14	4 x 14
Operating Range	Cooling	°F WB	57 - 77	57 - 77
	Heating	°F DB	59 - 81	59 - 81
Fan	Type		Turbo	Turbo
	Motor Output x Qty	W	24 x 1	24 x 1
	Motor/Drive		BLDC	BLDC
	Airflow (H/M/L)	CFM	272 / 208 / 155	314 / 258 / 198
Unit Data	Rated Amps	A	0.20	0.20
	Sound Pressure Level (H/M/L) ³	dB(A)	39 / 35 / 31	42 / 38 / 34
	Dimensions (WxHxD)	in	23-5/8 x 23-5/8 x 5-25/32	23-5/8 x 23-5/8 x 5-25/32
	Weight (Net/Shipping)	lbs	32.0 / 37.0	32.0 / 37.0
	Liquid Pipe	in	1/4	1/4
Piping	Vapor Pipe	in	3/8	3/8
	Drain (OD, ID)	in	27/32, 5/8	27/32, 5/8
Controller	Supplied		AKB73635607	AKB73635607

Digital Airflow Control

The airflow can be controlled to ensure maximum comfort and convenience.

Normal

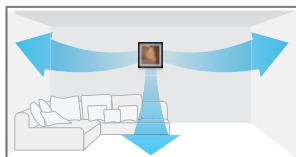

Jet Cool

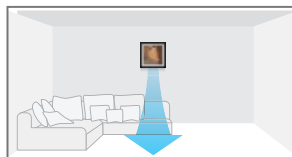

Sleep Mode

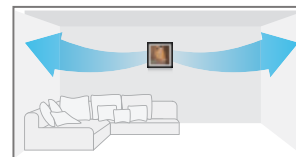

Customizable Picture Frame

With LG's revolutionary Art Cool Gallery, you can change the look of your air conditioner to whatever you want, whenever you want.



Note:

¹Rated capacity at 0 ft. above sea level with 25 ft. of refrigerant line and a 0 ft. level difference between outdoor and indoor unit.

²Rated cooling capacity obtained with air entering the indoor unit at 80°F dry bulb (DB) and 67°F wet bulb (WB) and outdoor ambient conditions of 95°F dry bulb (DB) and 75°F wet bulb (WB).
 Rated heating capacity obtained with air entering the indoor unit at 70°F dry bulb (DB) and 60°F wet bulb (WB) and outdoor ambient conditions of 47°F dry bulb (DB) and 43°F wet bulb (WB).

³All power/communication wiring minimum 4-conductor, stranded, shielded, and must comply with applicable local and national codes.

⁴Sound pressure levels are tested in an anechoic chamber under ISO Standard 3745 and are the same in both cooling and heating mode. These values can increase due to ambient conditions during operation.

Due to our commitment to continued innovation, some specifications may be changed without notification.

MULTI F INDOOR UNITS

LG ThinQ®



ART COOL™ Mirror

Specification	Unit	LAN090HSV5	LAN120HSV5	LAN181HSV5	
Capacity ^{1,2}	Cooling	Btu/h	9,000	12,000	18,000
	Heating	Btu/h	10,900	13,600	21,600
Power	Voltage	V, Hz, Ø	208/230, 60, 1	208/230, 60, 1	208/230, 60, 1
	Power/Communication Wiring ³	No. x AWG	4 x 14	4 x 14	4 x 14
Operating Range	Cooling	°F WB	57 - 77	57 - 77	57 - 77
	Heating	°F DB	59 - 81	59 - 81	59 - 81
Fan	Type		Cross Flow	Cross Flow	Cross Flow
	Motor Output x Qty	W	30 x 1	30 x 1	60 x 1
	Motor/Drive		BLDC	BLDC	BLDC
	Airflow (H/M/L)	CFM	268 / 218 / 169	282 / 233 / 177	558 / 438 / 353
	Rated Amps	A	0.40	0.40	0.40
Unit Data	Sound Pressure Level (H/M/L) ⁴	dB(A)	36 / 32 / 27	38 / 34 / 29	44 / 38 / 34
	Dimensions (WxHxD)	in	32-15/16 x 12-1/8 x 7-9/16	32-15/16 x 12-1/8 x 7-9/16	39-9/32 x 13-19/32 x 8-11/32
	Weight (Net/Shipping)	lbs	20.5 / 25.6	20.5 / 25.6	29.8 / 36.4
Piping	Liquid Pipe	in	1/4	1/4	1/4
	Vapor Pipe	in	3/8	3/8	1/2
	Drain (OD, ID)	in	27/32, 5/8	27/32, 5/8	27/32, 5/8
Controller	Supplied	AKB74955602	AKB74955602	AKB74955602	

LG ThinQ®



High Efficiency

Specification	Unit	LMN079HVT	LSN090HSV5	LSN120HSV5	LMN159HVT	LSN181HSV5	LMN249HVT	
Capacity ^{1,2}	Cooling	Btu/h	7,000	9,000	12,000	14,300	24,000	
	Heating	Btu/h	8,100	10,900	13,600	15,600	25,600	
Power	Voltage	V, Hz, Ø	208/230, 60, 1	208/230, 60, 1	208/230, 60, 1	208/230, 60, 1	208/230, 60, 1	
	Power/Communication Wiring ³	No. x AWG	4 x 14	4 x 14	4 x 14	4 x 14	4 x 14	
Operating Range	Cooling	°F WB	57 - 77	57 - 77	57 - 77	57 - 77	57 - 77	
	Heating	°F DB	59 - 81	59 - 81	59 - 81	59 - 81	59 - 81	
Fan	Type		Cross Flow	Cross Flow	Cross Flow	Cross Flow	Cross Flow	
	Motor Output x Qty	W	30 x 1	30 x 1	30 x 1	60 x 1	60 x 1	
	Motor/Drive		BLDC	BLDC	BLDC	BLDC	BLDC	
	Airflow (H/M/L)	CFM	254 / 204 / 148	268 / 218 / 169	282 / 233 / 177	314 / 268 / 184	558 / 438 / 353	597 / 452 / 367
	Rated Amps	A	0.40	0.40	0.40	0.40	0.40	
Unit Data	Sound Pressure Level (H/M/L) ⁴	dB(A)	35 / 31 / 26	36 / 32 / 27	38 / 34 / 29	42 / 38 / 32	44 / 38 / 34	46 / 41 / 36
	Dimensions (WxHxD)	in	32-15/16x12-1/8x7-7/16	32-15/16x12-1/8x7-7/16	32-15/16x12-1/8x7-7/16	32-15/16x12-1/8x7-7/16	39-9/32x13-19/32x8-9/32	39-9/32x13-19/32x8-9/32
	Weight (Net/Shipping)	lbs	18.3 / 23.4	18.3 / 23.4	18.3 / 23.4	18.3 / 23.4	25.6 / 32.2	25.6 / 32.2
Piping	Liquid Pipe	in	1/4	1/4	1/4	1/4	1/4	
	Vapor Pipe	in	3/8	3/8	3/8	3/8	1/2	
	Drain (OD, ID)	in	27/32, 5/8	27/32, 5/8	27/32, 5/8	27/32, 5/8	27/32, 5/8	
Controller	Supplied	AKB74955602	AKB74955602	AKB74955602	AKB74955602	AKB74955602	AKB74955602	

Note:

¹Rated capacity at 0 ft. above sea level with 25 ft. of refrigerant line and a 0 ft. level difference between outdoor and indoor unit.

²Rated cooling capacity obtained with air entering the indoor unit at 80 °F dry bulb (DB) and 67 °F wet bulb (WB) and outdoor ambient conditions of 95 °F dry bulb (DB) and 75 °F wet bulb (WB).
³Rated heating capacity obtained with air entering the indoor unit at 70 °F dry bulb (DB) and 60 °F wet bulb (WB) and outdoor ambient conditions of 47 °F dry bulb (DB) and 43 °F wet bulb (WB).

³All power/communication wiring minimum 4-conductor, stranded, shielded, and must comply with applicable local and national codes.

⁴Sound pressure levels are tested in an anechoic chamber under ISO Standard 3745 and are the same in both cooling and heating mode. These values can increase due to ambient conditions during operation.

Due to our commitment to continued innovation, some specifications may be changed without notification.

MULTI F INDOOR UNITS

MULTI-ZONE

INDOOR UNITS

LG ThinQ®



Low Wall Console

Specification	Unit	LQN090HV4	LQN120HV4	LMQN150HV	
Capacity ^{1,2}	Cooling	Btu/h	9,000	12,000	15,710
	Heating	Btu/h	10,500	13,650	17,070
Power	Voltage	V, Hz, Ø	208/230, 60, 1	208/230, 60, 1	208/230, 60, 1
	Power/Communication Wiring ³	No. x AWG	4 x 14	4 x 14	4 x 14
Operating Range	Cooling	°F WB	57 - 77	57 - 77	57 - 77
	Heating	°F DB	59 - 81	59 - 81	59 - 81
Fan	Type		Turbo	Turbo	Turbo
	Motor Output x Qty	W	48 x 1	48 x 1	48 x 1
	Motor/Drive		Brushless Digitally Controlled / Direct	Brushless Digitally Controlled / Direct	Brushless Digitally Controlled / Direct
	Airflow (H/M/L)	CFM	300 / 237 / 177	318 / 244 / 184	357 / 304 / 254
	Rated Amps	A	0.70	0.70	0.70
Unit Data	Sound Pressure Level (H/M/L) ⁴	dB(A)	38 / 32 / 27	39 / 32 / 27	44 / 39 / 35
	Dimensions (WxHxD)	in	27-9/16 x 23-5/8 x 8-9/32	27-9/16 x 23-5/8 x 8-9/32	27-9/16 x 23-5/8 x 8-9/32
	Weight (Net/Shipping)	lbs	35.7 / 41.7	35.7 / 41.7	35.7 / 41.7
Piping	Liquid Pipe	in	1/4	1/4	1/4
	Vapor Pipe	in	3/8	3/8	1/2
	Drain (OD, ID)	in	27/32, 5/8	27/32, 5/8	27/32, 5/8
Controller	Supplied	AKB75735410	AKB75735410	AKB75735410	

LG ThinQ®



Ceiling Cassette

Specification	Unit	LMCNO78HV	LCNO98HV4	LCN128HV4	LCN188HV4	
Capacity ^{1,2}	Cooling	Btu/h	7,000	9,000	12,000	18,000
	Heating	Btu/h	8,100	10,400	13,800	20,800
Power	Voltage	V, Hz, Ø	208/230, 60, 1	208/230, 60, 1	208/230, 60, 1	208/230, 60, 1
	Power/Communication Wiring ³	No. x AWG	4 x 14	4 x 14	4 x 14	4 x 14
Operating Range	Cooling	°F WB	57 - 77	57 - 77	57 - 77	57 - 77
	Heating	°F DB	59 - 81	59 - 81	59 - 81	59 - 81
Fan	Type		Turbo	Turbo	Turbo	
	Motor Output x Qty	W	43 x 1	43 x 1	43 x 1	
	Motor/Drive		BLDC	BLDC	BLDC	
	Airflow (H/M/L)	CFM	265 / 212 / 177	300 / 265 / 230	335 / 283 / 247	459 / 424 / 388
	Rated Amps	A	0.25	0.25	0.25	
Unit Data	Sound Pressure Level (H/M/L) ⁴	dB(A)	31 / 27 / 24	36 / 33 / 30	38 / 35 / 32	41 / 39 / 36
	Dimensions (WxHxD)	in	22-7/16 x 8-7/16 x 22-7/16	22-7/16 x 8-7/16 x 22-7/16	22-7/16 x 8-7/16 x 22-7/16	22-7/16 x 10-3/32 x 22-7/16
	Weight (Net/Shipping)	lbs	26.0 / 31.0	29.0 / 34.0	29.0 / 34.0	32.0 / 39.0
Piping	Liquid Pipe	in	1/4	1/4	1/4	
	Vapor Pipe	in	3/8	3/8	3/8	
	Drain (OD, ID)	in	1-1/4, 1	1-1/4, 1	1-1/4, 1	
Controller	Supplied ⁵	PWLSSB21H	PWLSSB21H	PWLSSB21H	PWLSSB21H	
Grille (Sold Separately)	Model	PT-QAGWO	PT-QAGWO	PT-QAGWO	PT-QAGWO	
Dimensions (WxHxD)	in	27-9/16 x 7/8 x 27-9/16	27-9/16 x 7/8 x 27-9/16	27-9/16 x 7/8 x 27-9/16	27-9/16 x 7/8 x 27-9/16	
	Weight (Net/Shipping)	lbs	7 / 11	7 / 9	7 / 9	7 / 11

Note:

¹Rated capacity at 0 ft. above sea level with 25 ft. of refrigerant line and a 0 ft. level difference between outdoor and indoor unit.

²Rated cooling capacity obtained with air entering the indoor unit at 80°F dry bulb (DB) and 67°F wet bulb (WB) and outdoor ambient conditions of 95°F dry bulb (DB) and 75°F wet bulb (WB).
³Rated heating capacity obtained with air entering the indoor unit at 70°F dry bulb (DB) and 60°F wet bulb (WB) and outdoor ambient conditions of 47°F dry bulb (DB) and 43°F wet bulb (WB).

⁴All power/communication wiring minimum 4-conductor, stranded, shielded, and must comply with applicable local and national codes.

⁵Sound pressure levels are tested in an anechoic chamber under ISO Standard 3745 and are the same in both cooling and heating mode. These values can increase due to ambient conditions during operation.

Due to our commitment to continued innovation, some specifications may be changed without notification.

MULTI F INDOOR UNITS

LG ThinQ®



Low Static Ducted

Specification	Unit	LMDN097HV4	LMDN127HV4	LMDN187HV4	
Capacity ^{1,2}	Cooling	Btu/h	9,000	12,000	18,000
	Heating	Btu/h	10,400	13,800	20,800
Power	Voltage	V, Hz, Ø	208/230, 60, 1	208/230, 60, 1	208/230, 60, 1
	Power/Communication Wiring ³	No. x AWG	4 x 14	4 x 14	4 x 14
Operating Range	Cooling	°F WB	57 - 77	57 - 77	57 - 77
	Heating	°F DB	59 - 81	59 - 81	59 - 81
Fan	Type		Sirocco	Sirocco	Sirocco
	Motor Output x Qty	W	19 x 1	5 x 1, 19 x 1	5 x 1, 19 x 1
	Motor/Drive		BLDC	BLDC	BLDC
	Airflow (H/M/L)	CFM	318 / 247 / 194	353 / 300 / 247	530 / 441 / 353
	Rated Amps	A	0.40	0.80	0.80
Unit Data	Factory Set External Static Pressure	in. wg	0.10	0.10	0.10
	Max. External Static Pressure	in. wg	0.20	0.20	0.20
	Sound Pressure Level (H/M/L) ⁴	dB(A)	30 / 26 / 23	31 / 28 / 27	36 / 34 / 31
	Dimensions (WxHxD)	in	27-9/16 x 7-15/32 x 27-9/16	35-7/16 x 7-15/32 x 27-9/16	35-7/16 x 7-15/32 x 27-9/16
	Weight (Net/Shipping)	lbs	39.0 / 46.0	51.0 / 60.0	48.5 / 57.3
Piping	Liquid Pipe	in	1/4	1/4	1/4
	Vapor Pipe	in	3/8	3/8	1/2
	Drain (OD, ID)	in	1-1/4, 1	1-1/4, 1	1-1/4, 1
Controller	Additional Accessory ⁵		Wired Controller	Wired Controller	Wired Controller

Convertible Mid Static Ducted

LG ThinQ®



Specification	Unit	LHN098HV1	LHN128HV1	LHN188HV1	LHN248HV1	
Capacity ^{1,2}	Cooling	Btu/h	9,000	12,000	18,000	24,000
	Heating	Btu/h	12,000	15,000	20,000	27,000
Power	Voltage	V, Hz, Ø	208/230, 60, 1	208/230, 60, 1	208/230, 60, 1	208/230, 60, 1
	Power/Communication Wiring ³	No. x AWG	4 x 14	4 x 14	4 x 14	4 x 14
Operating Range	Cooling	°F WB	57 - 77	57 - 77	57 - 77	57 - 77
	Heating	°F DB	59 - 81	59 - 81	59 - 81	59 - 81
Fan	Type		Sirocco	Sirocco	Sirocco	
	Motor Output x Qty	W	165 x 1	165 x 1	165 x 1	165 x 1
	Motor/Drive		BLDC	BLDC	BLDC	BLDC
	Airflow (H/M/L)	CFM	353 / 318 / 283	494 / 424 / 353	635 / 530 / 424	706 / 547 / 459
	Rated Amps	A	1.7	1.7	1.7	1.7
Unit Data	Factory Set External Static Pressure	in. wg	0.24	0.24	0.24	0.24
	Max. External Static Pressure	in. wg	0.59	0.59	0.59	0.59
	Sound Pressure Level (H/M/L) ⁴	dB(A)	28 / 27 / 26	31 / 29 / 28	36 / 32 / 29	38 / 33 / 30
	Dimensions (WxHxD)	in	35-7/16 x 9-21/32 x 27-9/16	35-7/16 x 9-21/32 x 27-9/16	35-7/16 x 9-21/32 x 27-9/16	35-7/16 x 9-21/32 x 27-9/16
	Weight (Net/Shipping)	lbs	61.5 / 71.7	61.5 / 71.7	61.5 / 71.7	64.2 / 74.3
Piping	Liquid Pipe	in	1/4	1/4	1/4	1/4
	Vapor Pipe	in	3/8	3/8	1/2	1/2
	Drain (OD, ID)	in	1-1/4, 31/32	1-1/4, 31/32	1-1/4, 31/32	1-1/4, 31/32
Controller	Additional Accessory ⁵		Wired Controller	Wired Controller	Wired Controller	

Note:

¹Rated capacity at 0 ft. above sea level with 25 ft. of refrigerant line and a 0 ft. level difference between outdoor and indoor unit.

²Rated cooling capacity obtained with air entering the indoor unit at 80°F dry bulb (DB) and 67°F wet bulb (WB) and outdoor ambient conditions of 95°F dry bulb (DB) and 75°F wet bulb (WB).

Rated heating capacity obtained with air entering the indoor unit at 70°F dry bulb (DB) and 60°F wet bulb (WB) and outdoor ambient conditions of 47°F dry bulb (DB) and 43°F wet bulb (WB).

³All power/communication wiring minimum 4-conductor, stranded, shielded, and must comply with applicable local and national codes.

⁴Sound pressure levels are tested in an anechoic chamber under ISO Standard 3745 and are the same in both cooling and heating mode. These values can increase due to ambient conditions during operation.

⁵All LG wired controls are compatible and can be considered for control.

Due to our commitment to continued innovation, some specifications may be changed without notification.



High Static Ducted

Specification	Unit	LHN248HV	LHN368HV	
Capacity ^{1,2}	Cooling	Btu/h	24,000	36,000
	Heating	Btu/h	27,000	40,000
Power	Voltage	V, Hz, Ø	208/230, 60, 1	208/230, 60, 1
	Power/Communication Wiring ³	No. x AWG	4 x 14	4 x 14
Operating Range	Cooling	°F WB	57 ~ 77	57 ~ 77
	Heating	°F DB	59 ~ 81	59 ~ 81
Fan	Type		Sirocco	Sirocco x 2
	Motor Output x Qty	W	136.5 x 1	259 x 1
	Motor/Drive		BLDC	BLDC
	Airflow (H/M/L)	CFM	777 / 706 / 636	1,130 / 989 / 848
Unit Data	Rated Amps	A	1.60	2.30
	Factory Set External Static Pressure	in. wg	0.24	0.24
	Max. External Static Pressure	in. wg	0.59	0.59
	Sound Pressure Level (H/M/L) ⁴	dB(A)	37 / 35 / 34	44 / 42 / 40
	Dimensions (WxHxD)	in	35-7/16 x 10-5/8 x 27-9/16	49-3/16 x 10-5/8 x 27-9/16
	Weight (Net/Shipping)	lbs	58.6 / 71.9	85.3 / 99.4
Piping	Liquid Pipe	in	1/4	3/8
	Vapor Pipe	in	1/2	5/8
	Drain (OD, ID)	in	1-1/4, 1	1-1/4, 1
Controller	Additional Accessory ⁵	Wired Controller	Wired Controller	

Multi-Position Air Handler Unit



Specification	Unit	LVN181HV4	LVN241HV4	LVN361HV4	
Capacity ^{1,2}	Cooling	Btu/h	18,000	24,000	36,000
	Heating	Btu/h	20,000	27,000	40,000
Power	Voltage	V, Hz, Ø	208/230, 60, 1	208/230, 60, 1	208/230, 60, 1
	Power/Communication Wiring ³	No. x AWG	4 x 14	4 x 14	4 x 14
Operating Range	Cooling	°F WB	57 ~ 77	57 ~ 77	57 ~ 77
	Heating	°F DB	59 ~ 81	59 ~ 81	59 ~ 81
Fan	Type		Sirocco	Sirocco	Sirocco
	Motor Output x Qty	W	250 x 1	250 x 1	250 x 1
	Motor/Drive		Constant CFM ECM	Constant CFM ECM	Constant CFM ECM
	Airflow (H/M/L)	CFM	640/580/480	710/640/480	990/880/800
Unit Data	Rated Amps	A	1.10	1.10	1.10
	Max. External Static Pressure	in. wg	0.70	0.70	0.70
	Sound Pressure Level (H/M/L) ⁴	dB(A)	35 / 33 / 30	36 / 34 / 30	44 / 41 / 39
	Dimensions (WxHxD)	in	18 x 48-11/16 x 21-1/4	18 x 48-11/16 x 21-1/4	18 x 48-11/16 x 21-1/4
	Weight (Net/Shipping)	lbs	123.5 / 135.1	123.5 / 135.1	129.0 / 140.0
	Liquid Pipe	in	1/4	1/4	3/8
Piping	Vapor Pipe	in	1/2	1/2	5/8
	Drain	in	Primary & Secondary: 3/4 FPT	Primary & Secondary: 3/4 FPT	Primary & Secondary: 3/4 FPT
Controller	Additional Accessory ⁵	Wired Controller	Wired Controller	Wired Controller	

Note:

¹Rated capacity at 0 ft. above sea level with 25 ft. of refrigerant line and a 0 ft. level difference between outdoor and indoor unit.

²Rated cooling capacity obtained with air entering the indoor unit at 80°F dry bulb (DB) and 67°F wet bulb (WB) and outdoor ambient conditions of 95°F dry bulb (DB) and 75°F wet bulb (WB).
³Rated heating capacity obtained with air entering the indoor unit at 70°F dry bulb (DB) and 60°F wet bulb (WB) and outdoor ambient conditions of 47°F dry bulb (DB) and 43°F wet bulb (WB).

³All power/communication wiring minimum 4-conductor, stranded, shielded, and must comply with applicable local and national codes.

⁴Sound pressure levels are tested in an anechoic chamber under ISO Standard 3745 and are the same in both cooling and heating mode. These values can increase due to ambient conditions during operation.

⁵All LG wired controls are compatible and can be considered for control.

Due to our commitment to continued innovation, some specifications may be changed without notification.



MULTI F MAX PIPING ACCESSORIES

Accessory Lineup

For	2 IDUs	3 IDUs	4 IDUs	4 IDUs
Branch Distribution Unit	 PMBD3620	 PMBD3630	 PMBD3640	 PMBD3641
Y-Branch		 PMBL5620	 PMBL5620	

Branch Distribution Unit Features

- Distribution of refrigerant to various indoor units
- 4 models (2, 3, 4 indoor units)
- Integral EEVs
- Controlling PCB inside the unit
- Internally insulated (prevents condensation)
- Flare joints for easy and clean installation
- Compact design (low height)
- Flexible installation

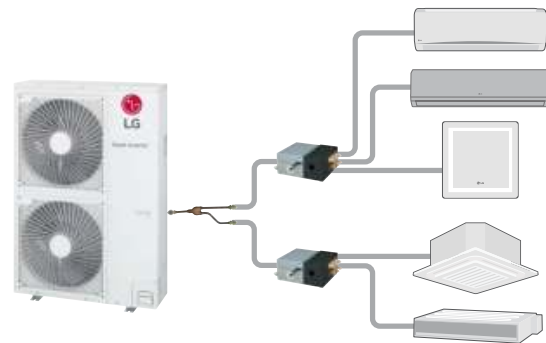

Specifications

Specification		Unit	PMBD3620	PMBD3630	PMBD3640	PMBD3641
Max Nominal	Each Port	Btu/h	24,000	24,000	24,000	Ports A - C: 24,000, Port D: 36,000
Port Capacity	Sum of Ports	Btu/h	48,000	72,000	73,000	73,000
Connectable Indoor Units¹			1 - 2	1 - 3	1 - 4	1 - 4
Operating Range		°F DB	0 - 150	0 - 150	0 - 150	0 - 150
Voltage		V, Hz, Ø	208/230, 60, 1	208/230, 60, 1	208/230, 60, 1	208/230, 60, 1
Power Input		W	16	24	32	32
Rated Amps		A	0.08	0.12	0.16	0.16
Dimensions	WxHxD	inch	17-3/32 x 6-13/32 x 10-23/32	17-3/32 x 6-13/32 x 10-23/32	17-3/32 x 6-13/32 x 10-23/32	17-3/32 x 6-13/32 x 10-23/32
Weight	Net	lbs	13.0	14.3	15.7	15.7
	Shipping	lbs	15.0	17.0	18.0	18.0
Pipe Connection Size (In from ODU)	Liquid	in	3/8	3/8	3/8	3/8
	Vapor	in	3/4	3/4	3/4	3/4
Pipe Connection Size (Out to IDU)	Liquid	in	1/4 (x2)	1/4 (x3)	1/4 (x4)	Ports A - C: 1/4 Port D: 1/4
	Vapor	in	3/8 (x2)	3/8 (x3)	3/8 (x4)	Ports A - C: 3/8 Port D: 1/2
Max Pipe Length	BD Box to IDU	ft	49.2	49.2	49.2	49.2
	BD Box to BD Box	ft	32.8	32.8	32.8	32.8
Max Pipe Elevation	BD Box to IDU	ft	49.2	49.2	49.2	49.2
	BD Box to BD Box	ft	49.2	49.2	49.2	49.2

Note:

¹ Branch Distribution Unit should be installed indoors.

Due to our commitment to continued innovation, some specifications may be changed without notification.

MULTI F PIPING SUMMARY

The following are examples of manual pipe size calculations. Designers are strongly encouraged to use LATS for Multi F systems.

Multi F Solution

Example shown: LMU363HV outdoor unit with four (4) indoor units connected.

Model Number	Min Length Each Pipe (ft.)	Maximum Piping Length to each IDU (ft.)				Max. Total Piping Length for Each System (ft.)
		A	B	C	D	
LMU183HV	10	82	82	-	-	164
LMU243HV	10	82	82	82	-	230
LMU303HV	10	82	82	82	82	246.1
LMU363HV	10	82	82	82	82	246.1

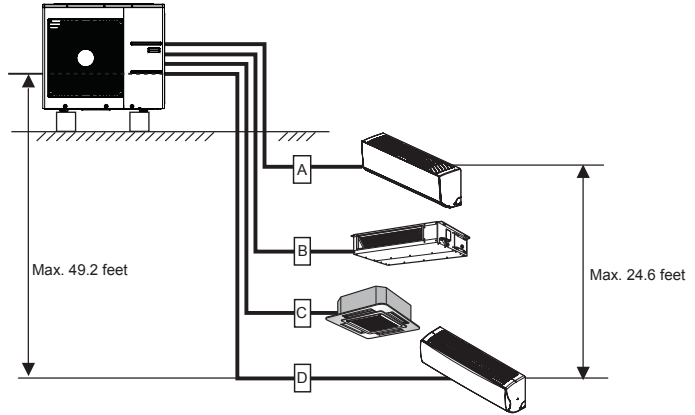

Multi F MAX Solution

Example: LMU543HV outdoor unit with seven (7) indoor units, and two (2) branch distribution units connected.
A, B, C, D: Pipes from Outdoor Unit to Indoor Unit

Pipe Length (ELF = Equivalent Length of pipe in Feet)	Total System Pipe Length ($\Sigma A + \Sigma B$)		≤ 475.7 feet
	Main pipe (Outdoor Unit to Branch Distribution Units: ΣA)	Minimum	16.4 feet
		Maximum	≤ 180.4 feet
	Total Branch Pipe Length (ΣB)		≤ 295.3 feet
Elevation Differential (All Elevation Limitations are Measured in Actual Feet)	Branch pipe (Branch Distribution Units to Indoor Units: ΣB)	Minimum	16.4 feet
		Maximum	≤ 49.2 feet
	If outdoor unit is above or below indoor unit (h_1)		≤ 98.4 feet
	Between the farthest two indoor units (h_2)		≤ 49.2 feet
	Between branch distribution unit and farthest connected indoor unit(s) (h_3)		≤ 32.8 feet
Between branch distribution units (h_4)		≤ 49.2 feet	

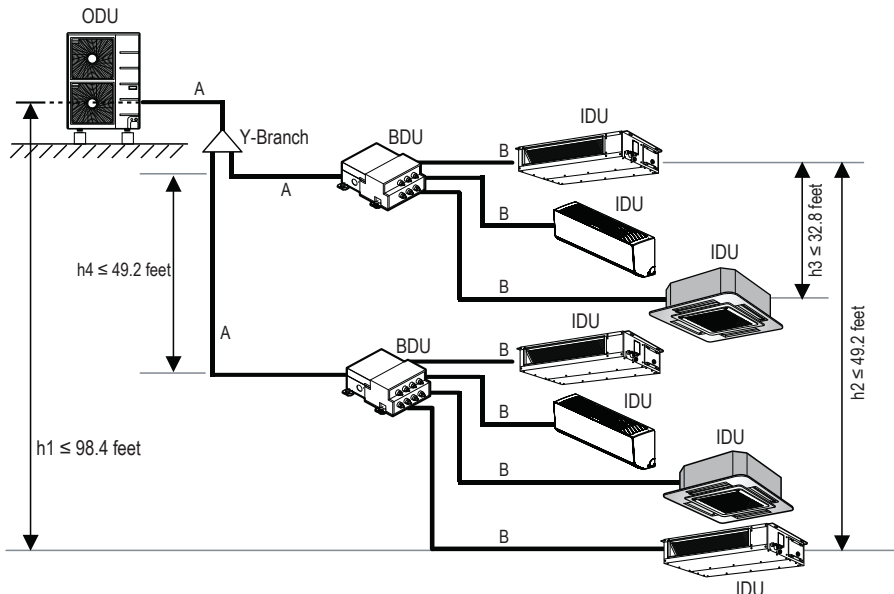

KEY:

ODU: Outdoor Unit
IDU: Indoor Unit
BDU: Branch Distribution Unit (s)
A, B, C, D: Pipes from ODU to IDU

ΣA : Main Pipe
 ΣB : Branch Pipe (BDU(s) to IDU(s))

CONTROLS

Individual Control



PREMTC00U



PREMTB100



PREMTA200



PWLSSB21H



PREMTBVC2,3,4



ZRTBS01

Model	Description
PREMTC00U	Simple Wired Remote Controller
PREMTB100	Standard III Wired Remote Controller
PREMTA200	Deluxe Wired Remote Controller
PWLSSB21H	Wireless Remote Controller
PREMTBVC2	LG MultiSITE™ Remote Controller
PREMTBVC3	LG MultiSITE™ Remote Controller with Motion and Humidity Sensor
PREMTBVC4	LG MultiSITE™ Remote Controller with ZigBee® Pro Wireless Network
ZRTBS01	Remote Temperature Button Sensor

LG MultiSITE™ Remote Controller Accessories



ZVRCZWOC1



ZVRCZMTH1



ZVRCZTRH1



ZVRCZCOC1



ZVRCZDWS1



ZVRCZDWC1



ZVRCZWLS1



VCM8002V504

Model	Description
ZVRCZPWC1/2	ZigBee Pro Wireless Card
ZVRCZWOC1	Wireless Ceiling Mounted Occupancy Sensor
ZVRCZMTH1	CRC1/2 Motion, Temperature, Humidity sensor (Motion only for CRC1)
ZVRCZTRH1	RC2 Wireless Temperature & RH sensor
ZEDCO2G5045	CRC2 Wireless CO2, Temperature & RH sensor
ZVRCZCOC1	Ceiling Mounted Occupancy Sensor
ZVRCZDWS1	Door & Window Switch
ZVRCZDWC1	CRC1/2 Door & Window Contact
ZVRCZWLS1	CRC2 Water Leak Sensor
VCM8002V504	CRC2 WiFi Card

Zigbee® is a registered trademark of Zigbee Alliance

Integration Devices



PBACNBTR0A



PMNFP14A1



PDRYCB100
PDRYCB320
PDRYCB400



PZCWRC1
PZCWRCG3



PACS5A000

Model	Description
PBACNBTR0A	LG MultiSITE™ Communications Manager
PDRYCB100	Simple Dry Contact
PDRYCB320	Dry Contact for Thermostat (5-12VDC, 24VAC)
PDRYCB400	Dry Contact for Economizer/Setback
PMNFP14A1	PI 485 for DFS
PZCWRC1	32.8' Wired Remote Extension Cable
PZCWRCG3	Group Control Cable Kit (required for each additional A/H with single zone controller)
PACS5A000	Central Control Integration Solution

ACCESSORIES

Indoor Accessories



PWFMD200



PRARH0
PRARS1



PT-AAGW0
PT-QAGW0



PTVK430



ANEH***B1
ANEH***B2

Type	Model	Description	Used with
Wi-Fi Module	PWFMD200	Connects to CN_WF or CN_WiFi depending on how the unit's board is marked	See Compatibility Table
Aux Heater Relay Kit	PRARH1	Auxiliary Heat Kit for Cassettes, Consoles and Ducted IDUs	See Compatibility Table
	PRARH0	Auxiliary Heat Kit for Cassettes, Consoles and Ducted IDUs	See Compatibility Table
	PRARS1	Auxiliary Heat Kit for Wall Mounted IDUs	See Compatibility Table
	PT-AAGW0	4-Way Ceiling Cassette 3X3 Grille	LCN***HV ¹
Cassette Grille	PT-QAGW0 ²	4-Way Ceiling Cassette 2x2 Grille	LMCN***HV, LCN***HV4
	PT-AFGW0S	Premium 3x3 Grille (includes Air Purification Kit)	LCN***HV ¹
	PT-AHMP0	Air Purification Kit	LCN***HV ¹
	PT-DCA	3x3 Decorative Cover	LCN***HV ¹
	PT-VSAA0	Human Detection Sensor	LCN***HV ¹
	PT-FSMA0	Floor Temperature Sensor	LCN***HV ¹
	Cassette Ventilation	PTVK430	3" Ø Ventilation Air Connection for all 4-Way Ceiling Cassettes
VAHU Heat Kit	ANEH033B1	3 kW Electric Heat Kit for VAHU	LVN**1HV4, LVN***HV
	ANEH053B1	5 kW Electric Heat Kit for VAHU	LVN**1HV4, LVN***HV
	ANEH083B2	8 kW Electric Heat Kit for VAHU	LVN**1HV4, LVN***HV
	ANEH103B2	10 kW Electric Heat Kit for VAHU	LVN**1HV4, LVN***HV
	ANEH153B2	15 kW Electric Heat Kit for VAHU	LVN***HV
	ANEH203B2	20 kW Electric Heat Kit for VAHU	LVN***HV
Mid Static Conversion Kit	ABDAMA0	Vertical Installation Conversion Kit	LHN098-248HV1
VAHU Down Flow Conversion Kit	PNDFJ0	Vertical Down Flow Conversion Kit	LVN**1HV4
	PNDFK0	Vertical Down Flow Conversion Kit	LVN***HV
HSD Filter Box	FBXM101A	High-capacity filter box for M1 chassis	LHN248HV
	FBXM201A	High-capacity filter box for M2 chassis	LHN368HV
	FBXM301A	High-capacity filter box for M3 chassis	LHN428HV, LHN488HV
	FBXMA01A	High-capacity filter box for MA chassis	LHN098-248HV1

Air Technologies



ARVU053ZEA2 / ARVU063ZEA2



ARVU093ZFA2 / ARVU123ZFA2



ARV00903RA6 / ARV01203RA6



PSNFP14A0

Category	Model	Description
ERV	ARVU053ZEA2	Energy Recovery Ventilator 465 cfm
	ARVU063ZEA2	Energy Recovery Ventilator 600 cfm
	ARVU093ZFA2	Energy Recovery Ventilator 900 cfm
	ARVU123ZFA2	Energy Recovery Ventilator 1,200 cfm
	ARV00903RA6	Residential Energy Recovery Ventilator 90 cfm
	ARV01203RA6	Residential Energy Recovery Ventilator 120 cfm
ERV Accessory	PSNFP14A0	PI485 for ERV (INDOOR)

Note:

¹ Accessory is not compatible with LCN***HV4 models.

² PTDCQ cover is compatible with 2x2 cassettes and a PT-UQC grille. Newer/smaller PT-QAGW0 grille does not fit the cover opening.

Due to our commitment to continued innovation, some specifications may be changed without notification.

ACCESSORIES

Outdoor Accessories



Base Pan Heater



Wind Baffle

Category	Model	Description	Used with
	ZLABGP01A	Wind Baffle for Low Ambient Cooling	LSU090HSV5 LSU120HSV5 LUU090HV LUU120HV
	ZLABGP03A	Wind Baffle for Low Ambient Cooling	LAU090HYV3 LAU120HYV3 LMU183HV LMU243HV
			LAU150HYV3 LAU180HYV3 LSU181HSV5 LAU240HYV3 LSU243HLV3 LSU303HLV3 LSU363HLV3 LUU180HHV LUU180HV LUU240HHV LUU240HV LUU360HHV LUU360HV
Wind Baffle	ZLABGP04A	Wind Baffle for Low Ambient Cooling	LUU420HHV LUU420HV LUU480HHV LUU480HV LMU180HHV LMU240HHV LMU300HHV LMU303HV LMU361HHV LMU363HV LMU421HHV LMU481HV LMU480HHV LMU541HV LMU601HV
			LMU303HV LMU363HV LMU483HV LMU543HV
	PQSH1200	Drain Pan Heater	LMU601HV LUU180HV LUU240HV LUU360HV LUU420HV LUU480HV
Drain Pan Heater	PQSH1202	Drain Pan Heater	LUU090HV LUU120HV
	PQSH1203	Drain Pan Heater	LMU183HV LMU243HV

Note:

- Multi F MAX, LUU36*HV, LUU42*HV, and LUU48*HV require Qty 2 of ZLABGP04A.
 - Drain Pan Heater is factory supplied for outdoor units featuring LGRED® heat, HLV3 outdoor units, and 9k and 12k Btu/h LSU***HSV5 outdoor units.
 - Drain Pan Heater is compatible with Multi F and Multi F MAX units manufactured after May 2015 and listed LUU***HV models manufactured after April 2017.
- Due to our commitment to continued innovation, some specifications may be changed without notification.

INDOOR CONTROLS AND ACCESSORIES COMPATIBILITY

Single Zone Indoor Accessories and Service Accessories



Single Zone		Wi-Fi Module w/ Cable	LG MultiSITE™ Remote Controllers	Simple Controller	Standard III Wired Remote Controller	Deluxe Wired Remote Controller	Dry Contact	Remote Temp/ Button Sensor	Group Control	Cable Extension	Aux Heater Relay Kit
		PWFMD200	PREMTBVC2 PREMTBVC3 PREMTBVC4	PREMTBVC2 PREMTBVC3 PREMTBVC4	PREMTB100	PREMTA200	PDRYCB100 PDRYCB320 PDRYCB400	ZRTBS01	PZCWRCG3 PZCWRC1	PRARH(0,1)	
Art Cool™ Mirror	LAN090HSV5	Built-In	0	0	0	0	0	X	X	0	-
	LAN120HSV5	Built-In	0	0	0	0	0	X	X	0	-
	LAN181HSV5	Built-In	0	0	0	0	0	X	X	0	-
Art Cool™ Premier	LAN090HYV3	Built-In	0	0	0	0	0	X	X	0	-
	LAN120HYV3	Built-In	0	0	0	0	0	X	X	0	-
	LAN150HYV3	Built-In	0	0	0	0	0	X	X	0	-
	LAN180HYV3	Built-In	0	0	0	0	0	X	X	0	-
	LAN240HYV3	Built-In	0	0	0	0	0	X	X	0	-
Extended Piping	LSN243HLV3	Built-In	0	0	0	0	0	X	X	0	-
	LSN303HLV3	Built-In	0	0	0	0	0	X	X	0	-
	LSN363HLV3	Built-In	0	0	0	0	0	X	X	0	-
High Efficiency	LSN090HSV5	Built-In	0	0	0	0	0	X	X	0	-
	LSN120HSV5	Built-In	0	0	0	0	0	X	X	0	-
	LSN181HSV5	Built-In	0	0	0	0	0	X	X	0	-
Standard Efficiency ³	LSN090HFV3	X	0	0	0	0	0	X	X	0	-
	LSN120HFV3	X	0	0	0	0	0	X	X	0	-
	LSN180HFV3	X	0	0	0	0	0	X	X	0	-
Mega ³	LSN240HFV3	X	0	0	0	0	0	X	X	0	-
	LSN090HEV2	X	0 ¹	0 ¹	0 ¹	0 ¹	0 ²	X	X	0	-
	LSN120HEV2	X	0 ¹	0 ¹	0 ¹	0 ¹	0 ²	X	X	0	-
	LSN180HEV2	X	0 ¹	0 ¹	0 ¹	0 ¹	0 ²	X	X	0	-
	LSN240HEV2	X	0 ¹	0 ¹	0 ¹	0 ¹	0 ²	X	X	0	-
Console	LSN090HXV2	X	0	0	0	0	0	X	X	0	-
	LSN120HXV2	X	0	0	0	0	0	X	X	0	-
	LSN180HXV2	X	0	0	0	0	0	X	X	0	-
4-Way Ceiling Cassette	LQN090HV4	0	0	0	0	0	0	0	0	0	0
	LQN120HV4	0	0	0	0	0	0	0	0	0	0
	LCN098HV4	0	0	0	0	0	0	0	0	0	0
	LCN128HV4	0	0	0	0	0	0	0	0	0	0
	LCN188HV4	0	0	0	0	0	0	0	0	0	0
	LCN249HV	0	0	0	0	0	0	0	0	0	0
	LCN369HV	0	0	0	0	0	0	0	0	0	0
Convertible Mid Static Ducted	LCN429HV	0	0	0	0	0	0	0	0	0	0
	LCN489HV	0	0	0	0	0	0	0	0	0	0
	LHN098HV1	0	0	0	0	0	0	0	0	0	0
	LHN128HV1	0	0	0	0	0	0	0	0	0	0
	LHN188HV1	0	0	0	0	0	0	0	0	0	0
High Static Ducted	LHN248HV1	0	0	0	0	0	0	0	0	0	0
	LHN248HV	0	0	0	0	0	0	0	0	0	0
	LHN368HV	0	0	0	0	0	0	0	0	0	0
	LHN428HV	0	0	0	0	0	0	0	0	0	0
Multi-Position AHU	LHN488HV	0	0	0	0	0	0	0	0	0	0
	LVN181HV4	0	0	0	0	0	0	0	0	0	0
	LVN241HV4	0	0	0	0	0	0	0	0	0	0
	LVN361HV4	0	0	0	0	0	0	0	0	0	0
	LVN420HV	0	0	0	0	0	0	0	0	0	0
LVN480HV	0	0	0	0	0	0	0	0	0	0	

Note:

"0" in a cell indicates available; "X" indicates not available; "-" indicates not applicable. Some IDUs have only a control wire terminal block (for field supplied control wire), while other IDUs have both a Molex connector (for LG control cable) and a control wire terminal block. See IDU engineering manual or installation manual for details.

¹ Accessory wired controllers are applicable for 9/12kBTu product manufactured July 2019+ and 18/24kBTu product manufactured January 22, 2020+

² Accessory dry contacts are applicable for product manufactured August 2019+

³IDU does not include Molex-to-terminal connection adapter, to connect field controller cable, order part #EAD63886215

Accessory Wi-Fi module is applicable for product manufactured June 2018+

Due to our commitment to continued innovation, some specifications may be changed without notification.

INDOOR CONTROLS AND ACCESSORIES COMPATIBILITY

Multi-Zone Indoor Accessories and Service Accessories



Multi-Zone	Wi-Fi Module w/ Cable	LG MultiSITE™ Remote Controllers	Simple Controller	Standard III Wired Remote Controller	Deluxe Wired Remote Controller	Dry Contact	Remote Temp Button Sensor	Group Control	Cable Extension	Aux Heater Relay Kit	Aux Heater Relay Kit	
	PWFMD200	PREMTBVC2 PREMTBVC3 PREMTBVC4	PREMTC00U	PREMTB100	PREMTA200	PDRYCB100 PDRYCB320 PDRYCB400	ZRTBS01	PZCWRCG3	PZCWRC1	PRARS1	PRARH(0,1)	
Art Cool™ Gallery	LMAN097HVP	O ¹	0	0	0	0	0	X	0	0	O ²	-
	LMAN127HVP	O ¹	0	0	0	0	0	X	0	0	O ²	-
Art Cool™ Mirror	LAN090HSV5	Built-In	0	0	0	0	0	X	0	0	0	-
	LAN120HSV5	Built-In	0	0	0	0	0	X	0	0	0	-
	LAN180HSV5	Built-In	0	0	0	0	0	X	0	0	0	-
High Efficiency	LMN079HVT	Built-In	0	0	0	0	0	X	0	0	0	-
	LSN090HSV5	Built-In	0	0	0	0	0	X	0	0	0	-
	LSN120HSV5	Built-In	0	0	0	0	0	X	0	0	0	-
	LMN159HVT	Built-In	0	0	0	0	0	X	0	0	0	-
	LSN180HSV5	Built-In	0	0	0	0	0	X	0	0	0	-
Console	LMN249HVT	Built-In	0	0	0	0	0	X	0	0	0	-
	LQN090HV4	0	0	0	0	0	0	0	0	0	-	0
	LQN120HV4	0	0	0	0	0	0	0	0	0	-	0
4-Way Ceiling Cassette	LMQN150HV	0	0	0	0	0	0	0	0	0	-	0
	LMCN078HV	0	0	0	0	0	0	0	0	0	-	0
	LCN098HV4	0	0	0	0	0	0	0	0	0	-	0
	LCN128HV4	0	0	0	0	0	0	0	0	0	-	0
Low Static Ducted	LCN188HV4	0	0	0	0	0	0	0	0	0	-	0
	LMDN097HV4	O ³	0	0	0	0	0	0	0	0	-	0
	LMDN127HV4	O ³	0	0	0	0	0	0	0	0	-	0
Convertible Mid Static Ducted	LMDN187HV4	0	0	0	0	0	0	0	0	0	-	0
	LHN098HV1	0	0	0	0	0	0	0	0	0	-	0
	LHN128HV1	0	0	0	0	0	0	0	0	0	-	0
	LHN188HV1	0	0	0	0	0	0	0	0	0	-	0
High Static Ducted	LHN248HV1	0	0	0	0	0	0	0	0	0	-	0
	LHN248HV	0	0	0	0	0	0	0	0	0	-	0
	LHN368HV	0	0	0	0	0	0	0	0	0	-	0
Multi-Position AHU	LHN181HV4	0	0	0	0	0	0	0	0	0	-	0
	LVN241HV4	0	0	0	0	0	0	0	0	0	-	0
	LVN361HV4	0	0	0	0	0	0	0	0	0	-	0

Note:

"O" in a cell indicates available; "X" indicates not available; "-" indicates not applicable. Some IDUs have only a control wire terminal block (for field supplied control wire), while other IDUs have both a Molex connector (for LG control cable) and a control wire terminal block. See IDU engineering manual or installation manual for details.

¹ Accessory Wi-Fi module is applicable for product manufactured January 2019+

² Emergency Heat function is not available with Aux Heat Relay Kit

³ Accessory Wi-Fi module is applicable for product manufactured June 2018+

Due to our commitment to continued innovation, some specifications may be changed without notification.

OUTDOOR CONTROLS AND ACCESSORIES COMPATIBILITY

Single Zone Outdoor Accessories and Service Accessories



PMNFP14A1



PQNUD1S41



PACSSA000



PBACNBTR0A



ZHWLONWK0



PLGMVW100

Single Zone		PI485 for ODU	PDI Premium	Central Control Integration Solution	AC Smart BACnet®	LG MultiSITE™ Communications Manager	LonWorks Module ¹	Mobile LGMV	LGMV Service Tool
		PMNFP14A1	PQNUD1S41	PACSSA000	PBACNA000	PBACNBTR0A	ZHWLONWK0	PLGMVW100	PRCTI0
High Efficiency	LSU090HSV5	0	0	0	0	0	0	0	0
	LSU120HSV5	0	0	0	0	0	0	0	0
Art Cool™ Mirror	LSU181HSV5	0	0	0	0	0	0	0	0
Art Cool™ Premier	LAU090HYV3	0	0	0	0	0	0	0	0
	LAU120HYV3	0	0	0	0	0	0	0	0
	LAU150HYV3	0	0	0	0	0	0	0	0
	LAU180HYV3	0	0	0	0	0	0	0	0
	LAU240HYV3	0	0	0	0	0	0	0	0
Extended Piping	LSU243HLV3	0	0	0	0	0	0	0	0
	LSU303HLV3	0	0	0	0	0	0	0	0
	LSU363HLV3	0	0	0	0	0	0	0	0
Standard Efficiency	LSU090HFV3	X	X	X	X	X	X	0	0
	LSU120HFV3	X	X	X	X	X	X	0	0
	LSU180HFV3	X	X	X	X	X	X	0	0
	LSU240HFV3	X	X	X	X	X	X	0	0
Mega	LSU090HEV2	X	X	X	X	X	X	0	0
	LSU120HEV2	X	X	X	X	X	X	0	0
	LSU180HEV2	X	X	X	X	X	X	0	0
	LSU240HEV2	X	X	X	X	X	X	0	0
	LSU090HXV2	X	X	X	X	X	X	0	0
LSU120HXV2	X	X	X	X	X	X	0	0	
Console	LUU090HV	0	0	0	0	0	0	0	0
	LUU120HV	0	0	0	0	0	0	0	0
	LUU180HV	0	0	0	0	0	0	0	0
4-Way Ceiling Cassette	LUU240HV	0	0	0	0	0	0	0	0
	LUU360HV	0	0	0	0	0	0	0	0
Convertible Mid Static Ducted	LUU420HV	0	0	0	0	0	0	0	0
	LUU480HV	0	0	0	0	0	0	0	0
High Static Ducted	LUU180HHV	0	0	0	0	0	0	0	0
	LUU240HHV	0	0	0	0	0	0	0	0
Multi-Position AHU	LUU360HHV	0	0	0	0	0	0	0	0
	LUU420HHV	0	0	0	0	0	0	0	0
	LUU480HHV	0	0	0	0	0	0	0	0

Note:

"0" in a cell indicates available; "X" indicates not available; "-" indicates not applicable.

¹LonWorks module requires the LG MultiSITE™ Communications Manager (PBACNBTR0A).

Due to our commitment to continued innovation, some specifications may be changed without notification.

OUTDOOR CONTROLS AND ACCESSORIES COMPATIBILITY

Multi-Zone Outdoor Accessories and Service Accessories



PMNFP14A1



PQNUD1S41



PACS5A000



PBACNBTR0A



ZHWLONWK0



PLGMVW100

Multi-Zone	PI485 for ODU	PDI Premium	Central Control Integration Solution	LG MultiSITE™ Communications Manager	LG MultiSITE™ VM3	LonWorks® Module ¹	Mobile LGMV	LGMV Service Tool
	PMNFP14A1	PQNUD1S41	PACS5A000	PBACNBTR0A	PBACNBTR1B	ZHWLONWK0	PLGMVW100	PRCTILO
Multi F	LMU183HV	0	0	0	0	0	0	0
	LMU180HHV	0	0	0	0	0	0	0
	LMU243HV	0	0	0	0	0	0	0
	LMU240HHV	0	0	0	0	0	0	0
	LMU303HV	0	0	0	0	0	0	0
	LMU300HHV	0	0	0	0	0	0	0
	LMU363HV	0	0	0	0	0	0	0
Multi F MAX	LMU361HHV	0	0	0	0	0	0	0
	LMU421HHV	0	0	0	0	0	0	0
	LMU480HHV	0	0	0	0	0	0	0
	LMU483HV	0	0	0	0	0	0	0
	LMU543HV	0	0	0	0	0	0	0
	LMU601HV	0	0	0	0	0	0	0

Note:

"0" in a cell indicates available; "X" indicates not available; "-" indicates not applicable. IDUs shown compatible with wired Premium Remote Controller are compatible with all LG wired controllers. Some IDUs have only a control wire terminal block (for field supplied control wire), while other IDUs have both a Molex connector (for LG control cable) and a control wire terminal block. See IDU engineering manual or installation manual for details.

¹ LonWorks module requires the LG MultiSITE™ Communications Manager (PBACNBTR0A) or the LG MultiSITE™ VM3 Controller (PBACNBTR1B)

Due to our commitment to continued innovation, some specifications may be changed without notification.



Single Zone Solutions

Product	System Model	Indoor Model	Outdoor Model	AHRI Ref #	SEER2	EER2 95° F	HSPF2	Energy Star 6.1	Energy Star Cold Climate
115V Mega	LS090HXV2	LSN090HXV2	LSU090HXV2	203996859	20	12.3	9.2	Yes	
	LS120HXV2	LSN120HXV2	LSU120HXV2	203996860	19	10.5	9		
Mega 17 SEER	LS090HFV3	LSN090HFV3	LSU090HFV3	206606850	17	12.5	8.7	Yes	
	LS120HFV3	LSN120HFV3	LSU120HFV3	206606848	17	10.5	8.5		
	LS180HFV3	LSN180HFV3	LSU180HFV3	206606851	17	12	8.9	Yes	
	LS240HFV3	LSN240HFV3	LSU240HFV3	206606849	17	11	8.3		
Mega	LS090HEV2	LSN090HEV2	LSU090HEV2	202544305	20	12.5	9.2	Yes	
	LS120HEV2	LSN120HEV2	LSU120HEV2	202544306	19	10.5	9		
	LS180HEV2	LSN180HEV2	LSU180HEV2	202544307	19	12	9.4	Yes	
	LS240HEV2	LSN240HEV2	LSU240HEV2	202544308	19	11	8.8		
Art Cool Premier	LA090HYV3	LAN090HYV3	LAU090HYV3	204825177	27	15.8	13.5	Yes	Yes
	LA120HYV3	LAN120HYV3	LAU120HYV3	204825178	25.5	13.8	11.2	Yes	Yes
	LA150HYV3	LAN150HYV3	LAU150HYV3	204825179	25	15	11	Yes	Yes
	LA180HYV3	LAN180HYV3	LAU180HYV3	204825180	24	14.4	10.8	Yes	Yes
	LA240HYV3	LAN240HYV3	LAU240HYV3	204825181	23	13	10	Yes	Yes
	LA090HSV5	LAN090HSV5	LSU090HSV5	10567393	23.2	14.5	10.2	Yes	Yes
Art Cool Mirror	LA120HSV5	LAN120HSV5	LSU120HSV5	10570122	22	12.5	10	Yes	Yes
	LA181HSV5	LAN181HSV5	LSU181HSV5	207462345	22	12.55	9.5	Yes	Yes
	LS090HSV5	LSN090HSV5	LSU090HSV5	10567394	23.2	14.5	10.2	Yes	Yes
High Efficiency	LS120HSV5	LSN120HSV5	LSU120HSV5	10570123	22	12.5	10	Yes	Yes
	LS181HSV5	LSN181HSV5	LSU181HSV5	207348503	22	12.55	9.5	Yes	Yes
	LS243HLV3	LSN243HLV3	LSU243HLV3	204825182	22	13	9.5	Yes	Yes
Extended Piping	LS303HLV3	LSN303HLV3	LSU303HLV3	204825183	20.5	11.3	7.9		
	LS363HLV3	LSN363HLV3	LSU363HLV3	204825184	19	10	7.9		
	LC098HV	LCN098HV4	LUU090HV	211234500	20.2	13.65	10.55	Yes	Yes
Cassette	LC128HV	LCN128HV4	LUU120HV	211234502	19.4	12.6	10.35	Yes	Yes
	LC188HV	LCN188HV4	LUU180HV	211234504	20.5	12.5	9.7	Yes	Yes
	LC249HV	LCN249HV	LUU240HV	211234513	20	11.7	10.2	Yes	Yes
	LC369HV	LCN369HV	LUU360HV	211234508	21	12.5	10	Yes	Yes
	LC429HV	LCN429HV	LUU420HV	211234514	19.3	10.45	10.05		Yes
LGRID® Cassette	LC188HHV4	LCN188HV4	LUU180HHV	205788763	20.0	12.8	9.4	Yes	Yes
	LC249HHV	LCN249HV	LUU240HHV	205788764	21	12.6	10.2	Yes	Yes
	LC369HHV	LCN369HV	LUU360HHV	205788768	21.5	12.6	10.55	Yes	Yes
	LC429HHV	LCN429HV	LUU420HHV	205788765	19.5	12.8	10.75	Yes	Yes
Low Wall Console	LQ090HV	LQN090HV4	LUU090HV	211234501	21	12.6	10.4	Yes	Yes
	LQ120HV	LQN120HV4	LUU120HV	211234503	20.8	12.6	10.2	Yes	Yes
Convertible Mid Static Duct	LH098HV1	LHN098HV1	LUU090HV	212578846	16	11.8	10.4	Yes	Yes
	LH128HV1	LHN128HV1	LUU120HV	212578845	16	11.7	10.5	Yes	Yes
	LH188HV1	LHN188HV1	LUU180HV	212578844	17.8	12.6	9.9	Yes	Yes
	LH248HV1	LHN248HV1	LUU240HV	212578843	18.5	11.8	10.4	Yes	Yes
High Static Duct	LH248HV	LHN248HV	LUU240HV	211234506	16.85	11.7	9	Yes	Yes
	LH368HV	LHN368HV	LUU360HV	211234509	18.85	11.85	9.2	Yes	Yes
	LV120HCV	LVN120HCV	LVU120HCV	211078860	16	12.2	9.3	Yes	
Multi-Position Air Handler Unit CV	LV180HCV	LVN181HV4	LVU180HCV	211126484	15.6	11	8.7		
	LV240HCV	LVN241HV4	LVU240HCV	211126485	15.1	9.5	8.5		
	LV300HCV	LVN300HCV	LVU300HCV	211126486	15.5	9.5	9.1		
	LV181HV	LVN181HV4	LUU180HV	211234505	17.25	12.3	9.25	Yes	Yes
Multi-Position Air Handler Unit	LV241HV	LVN241HV4	LUU240HV	211234507	17.6	11.70	9.7	Yes	Yes
	LV300HV	LVN300HCV	LUU360HV	213361978	17.00	12.80	9.20	Yes	Yes
	LV361HV	LVN361HV4	LUU360HV	211234510	16.25	11.90	8.95	Yes	Yes
	LV420HV1	LVN420HV	LUU420HV	211234515	17.2	10.75	9.35	Yes	Yes
	LV420HV2	LVN420HV	LUU601HV	213361979	17.20	11.70	9.30	Yes	Yes
	LV480HV1	LVN480HV	LUU480HV	211234516	16.5	9.7	9.3	Yes	Yes
	LV480HV2	LVN480HV	LUU601HV	213361980	17.50	11.70	9.20	Yes	Yes
	LV600HV1	LVN600HV	LUU601HV	213361981	16.50	11.70	9.20	Yes	Yes
LGRID® VAHU	LV181HHV4	LVN181HV4	LUU180HHV	205788774	17.05	13.35	8.9	Yes	Yes
	LV241HHV4	LVN241HV4	LUU240HHV	205788775	16.45	11.90	9.25	Yes	Yes
	LV361HHV4	LVN361HV4	LUU360HHV	205788773	16.4	11.95	9.3	Yes	Yes
	LV420HHV	LVN420HV	LUU420HHV	205788776	17.3	12.00	9.45	Yes	Yes
	LV480HHV	LVN480HV	LUU480HHV	205788777	17.75	11.95	9.4	Yes	Yes
LGRID® Mid Static Duct	LH188HHV1	LHN188HV1	LUU180HHV	212578842	17.5	12.3	9.2	Yes	Yes
	LH248HHV1	LHN248HV1	LUU240HHV	212578847	16.75	11.8	9.4	Yes	Yes
	LH248HHV4	LHN248HV	LUU240HHV	205788767	16.75	12.0	9.4	Yes	Yes
LGRID® High Static Duct	LH368HHV4	LHN368HV	LUU360HHV	205788769	18.3	12.0	9.2	Yes	Yes
	LH428HHV	LHN428HV	LUU420HHV	205788770	18.7	12.05	9.15	Yes	Yes
	LH488HHV	LHN488HV	LUU480HHV	205788772	17.7	11.7	9.4	Yes	Yes

Multi-Zone Solutions

Multi F	System Model	AHRI Ref #	SEER2	EER2 95° F	HSPF2	Energy Star 6.1	Energy Star Cold Climate
18MBH	LMU183HV Non-Ducted Combination	208131884	22.5	13.5	9.6	Yes	
	LMU183HV Mixed Combination	208132537	20.5	13.0	9.3	Yes	
	LMU183HV Ducted Combination	208131885	18.5	12.5	9	Yes	
24MBH	LMU243HV Non-Ducted Combination	208131886	22.5	12.5	9.4	Yes	
	LMU243HV Mixed Combination	208132538	20.5	12.5	9.2	Yes	
	LMU243HV Ducted Combination	208131887	18.5	12.5	9.0	Yes	
30MBH	LMU303HV Non-Ducted Combination	208131888	22	13	9.2	Yes	
	LMU303HV Mixed Combination	208132539	20.25	12.5	9.0	Yes	
	LMU303HV Ducted Combination	208131889	18.5	12	8.8	Yes	
36MBH	LMU363HV Non-Ducted Combination	208131890	21.5	12.5	9.0	Yes	
	LMU363HV Mixed Combination	208132540	19.75	12.1	8.8	Yes	
	LMU363HV Ducted Combination	208131891	18	11.7	8.6	Yes	
48MBH	LMU483HV Non-Ducted Combination	210529233	20.8	12.8	9.5	Yes	
	LMU483HV Mixed Combination	210568062	19.9	12.7	9.5	Yes	
	LMU483HV Ducted Combination	210529234	19	12.6	9.5	Yes	
54MBH	LMU543HV Non-Ducted Combination	210529235	20.6	12.6	9.3	Yes	
	LMU543HV Mixed Combination	210568063	19.55	12.55	9.3	Yes	
	LMU543HV Ducted Combination	210529236	18.5	12.5	9.3	Yes	
60MBH	LMU601HV Non-Ducted Combination	206717015	20.5	11.3	10		Yes
	LMU601HV Mixed Combination	206717016	19.5	11.15	9.75		Yes
	LMU601HV Ducted Combination	206717003	18.5	11	9.5		Yes

ENERGY STAR®

Multi-Zone Solutions with LGRED°

Multi F LGRED°	System Model	AHRI Ref #	SEER2	EER2 95° F	HSPF2	Energy Star 6.1	Energy Star Cold Climate
18MBH	LMU180HHV Non-Ducted Combination	10445372	21	13.5	9.2	Yes	Yes
	LMU180HHV Mixed Combination	10516996	19.25	12.75	8.9	Yes	Yes
	LMU180HHV Ducted Combination	10445373	17.5	12	8.6	Yes	Yes
24MBH	LMU240HHV Non-Ducted Combination	10445374	21	13.5	9.8	Yes	Yes
	LMU240HHV Mixed Combination	10516997	19	12.6	9.5	Yes	Yes
	LMU240HHV Ducted Combination	10445375	17	11.7	9.2	Yes	Yes
30MBH	LMU300HHV Non-Ducted Combination	10445376	20	12.5	9.8	Yes	Yes
	LMU300HHV Mixed Combination	10525928	18.75	12.1	9.5	Yes	Yes
	LMU300HHV Ducted Combination	10445377	17.5	11.7	9.2	Yes	Yes
36MBH	LMU361HHV Non-Ducted Combination	206717007	22	14.5	11	Yes	Yes
	LMU361HHV Mixed Combination	206717012	20.5	14	10.5	Yes	Yes
	LMU361HHV Ducted Combination	206717006	19	13.5	10	Yes	Yes
42MBH	LMU421HHV Non-Ducted Combination	206717001	21.5	13.8	11	Yes	Yes
	LMU421HHV Mixed Combination	206717013	20.25	13.45	10.5	Yes	Yes
	LMU421HHV Ducted Combination	206717008	19	13.1	10	Yes	Yes
48MBH	LMU480HHV Non-Ducted Combination	206717002	20.5	13.1	10.5	Yes	Yes
	LMU480HHV Mixed Combination	206717014	19.5	12.85	10.25	Yes	Yes
	LMU480HHV Ducted Combination	206717009	18.5	12.6	10	Yes	Yes



ENERGY STAR® is a joint program of the U.S. Environmental Protection Agency (EPA) and the U.S. Department of Energy (DOE) created to promote energy-efficient products and practices. The ENERGY STAR® logo helps homeowners identify which products meet energy efficiency performance levels set by U.S. EPA and U.S. DOE. Proper sizing and installation of equipment is critical to achieve optimal performance. Split system air conditioners and heat pumps (excluding ductless systems) must be matched with appropriate coil components to meet ENERGY STAR criteria. Ask your contractor for details or visit www.energystar.gov.

Select LG air conditioning systems may make homeowners eligible for equipment-related tax benefits and credits. Visit rebates.lghvac.com to see if your LG Air Conditioning System qualifies.

For the most up-to-date list of ENERGY STAR® models, visit the AHRI Directory at ahridirectory.org.

ENERGY STAR® and the ENERGY STAR mark are registered trademarks owned by the U.S. Environmental Protection Agency.

HOW TO READ LG MODEL NUMBERS

SINGLE ZONE SOLUTIONS – INDOOR/OUTDOOR

L	A	N	09	0	H	YV	3
Brand	Family	Component	Nominal Capacity	Generation	Cycle	Product Type	Features

Brand	L	LG		
Family	A	Art Cool™ Wall Mounted	H	Ceiling-Concealed Duct (Mid/High Static)
	C	Four-Way Ceiling Cassette	S	Standard Wall Mounted
	D	Ceiling-Concealed Duct (Low Static)	U	Cassette/Duct ODU
	Q	Console	V	Vertical Air Handler Unit
Component	N	Indoor Unit	U	Outdoor Unit
Nominal Capacity	09	9,000	24	24,000
	12	12,000	30	30,000
	15	15,000	36	36,000
	18	18,000	42	42,000
			48	48,000
Generation	0-8			
Cycle	H	Heat Pump		
Product Type	EV	Mega Inverter	V	Standard Inverter
	FV	Standard Efficiency	XV	Mega 115V Inverter
	LV	Extended Pipe Inverter	YV	Art Cool™ Premier Inverter
	HV	High Heat (LGRED°) Inverter Heat Pump		
	SV	Art Cool™ Mirror Inverter & High-Efficiency Inverter		
Features	1-2-3-4-5	Model-Specific Features/Improvements		

MULTI-ZONE SOLUTIONS – INDOOR/OUTDOOR¹

L	M	N	15	9	HV	T
Brand	Family	Product	Nominal Capacity	Generation	Cycle/Type	Style

Brand	L	LG		
Family	M	Multi-Zone		
Product	AN	Art Cool™ Wall Mounted Indoor Unit	N	Standard Wall Mounted Indoor Unit
	CN	Four-Way Ceiling-Cassette Indoor Unit	VN	Vertical-Horizontal Air Handler Indoor Unit
	DN	Ceiling-Concealed Duct (Low Static) Indoor Unit	U	Outdoor Unit
	HN	Ceiling-Concealed Duct (Mid/High Static) Indoor	QN	Console
Nominal Capacity	07	7,000	30	30,000
	09	9,000	36	36,000
	12	12,000	42	42,000
	15	15,000	48	48,000
	18	18,000	54	54,000
	24	24,000	60	60,000
Generation	0-5-6-7-8-9-C			
Cycle/Type	HV	Inverter Heat Pump	HHV	High Heat (LGRED°) Inverter Heat Pump
Style	P	Art Cool™ Gallery IDU	T	High Wall IDU

Note:
Multi-compatible Single Zone IDU nomenclature is conveyed in the Single Zone Solutions Section.





LG residential HVAC provides energy-efficient comfort all across the nation to people at home. As an industry leader, LG residential and light commercial systems are comprised of cutting-edge technologies which contribute to their efficiency, quality and performance. From the impressive heating capabilities of LGRED^o Technology to the truly connected home HVAC experience of LG ThinQ™, explore the innovative features that make LG residential and light commercial systems easier to sell, install and service.



LG Electronics USA, Inc.

Air Conditioning Technologies

4300 North Point Parkway, Alpharetta, GA 30022

www.lghvac.com

Distributed by

©2024 LG Electronics U.S.A. All rights reserved.

PC_Single_Multi_DFS_Systems_04_24

The AHRI Certified® mark indicates LG Electronics (LG) participation in the AHRI Certification program. For verification of individual certified products, go to www.ahridirectory.org.

CSA Group® is a registered trademark of Canadian Standards Association. All indoor and outdoor units are certified by the CSA Group, control number 192279.

USGBC® and the related logo are trademarks owned by the U.S. Green Building Council and are used with permission.